



Air Conditioners

Technical Data

Outdoor unit - Optimized for seasonal efficiency



EEDEN12-100

RZQG-L7V1

TABLE OF CONTENTS

RZQG-L7V1

1	Features	2
2	Specifications	3
	Nominal Capacity And Nominal Input	3
	Technical Specifications	6
	Electrical Specifications	8
3	Electrical data	9
	Electrical Data	9
4	Options	11
	Options	11
5	Combination table	12
	Combination Table	12
6	Capacity tables	13
	Cooling Capacity Tables	13
	Heating Capacity Tables	17
	Capacity Correction Factor	21
7	Dimensional drawings	22
	Dimensional Drawings	22
8	Centre of gravity	23
	Centre of Gravity	23
9	Piping diagrams	24
	Piping Diagram	24
	Piping Diagram Twin Application	25
	Piping Diagram Triple Application	26
	Piping Diagram Double Twin Application	27
10	Wiring diagrams	28
	Wiring Diagrams - Single Phase	28
11	Sound data	29
	Sound Power Spectrum	29
	Sound Pressure Spectrum - Cooling	30
	Sound Pressure Spectrum - Heating	31
	Sound Pressure Spectrum Quiet Mode	32
12	Installation	33
	Installation Method	33

1 Features

- Seasonal efficiency gives an indication on how efficient an air conditioner operates over an entire heating or cooling season.
- Seasonal efficiency, optimized for all seasons.
- Seasonal smart series already comply with EU's 2014 Eco-Design requirements
- Suits computer room applications (EDP)
- Re-use of existing R-22 or R-407C technology
- Extended operation range down to -20°C in heating
- Maximum piping length up to 75m, minimum piping length has no limitation
- Daikin outdoor units are neat, sturdy and can easily be mounted on a roof or terrace or simply placed against an outside wall

1



2 Specifications

2-1 Nominal Capacity And Nominal Input				FCQHG71FVEB / RZQG71L7V1B	FCQHG100FVEB / RZQG100L7V1B	FCQHG125FVEB / RZQG125L7V1B	FCQHG140FVEB / RZQG140L7V1B
Cooling capacity	Nom.		kW	6.8 (3)	9.5 (3)	12.0 (3)	13.4 (3)
Heating capacity	Nom.		kW	7.5 (4)	10.8 (4)	13.5 (4)	15.5 (4)
Power input	Cooling	Nom.	kW	1.66	2.15	3.00	4.00
	Heating	Nom.	kW	1.56	2.16	3.07	3.77
EER				4.09	4.42	4.00	3.35
COP				4.80	4.99	4.40	4.12
SEER				6.11 (6)	6.21 (6)	6.00 (6)	-
SCOP				4.18 (6)	4.30 (6)	3.89 (6)	-
Annual energy consumption			kWh	830	1,075	1,500	2,000
Energy label	Cooling			A			
	Heating			A			

Notes

- (1) Energy label: scale from A (most efficient) to G (less efficient)
- (2) Annual energy consumption: based on average use of 500 running hours per year at full load (nominal conditions)
- (3) Cooling: indoor temp. 27°CDB, 19°CWB; outdoor temp. 35°CDB; equivalent piping length: 5m; level difference: 0m
- (4) Heating: indoor temp. 20°CDB; outdoor temp. 7°CDB, 6°CWB; equivalent refrigerant piping: 5m; level difference: 0m
- (5) Annual energy consumption is according to Energy labeling directive 2002/31/EC
- (6) SEER and SCOP are according to EN 14825

2-1 Nominal Capacity And Nominal Input				FCQG71FVEB / RZQG71L7V1B	FCQG100FVEB / RZQG100L7V1B	FCQG125FVEB / RZQG125L7V1B	FCQG140FVEB / RZQG140L7V1B
Cooling capacity	Nom.		kW	6.8 (3)	9.5 (3)	12.0 (3)	13.4 (3)
Heating capacity	Nom.		kW	7.5 (4)	10.8 (4)	13.5 (4)	15.5 (4)
Power input	Cooling	Nom.	kW	2.01	2.45	3.22	4.17
	Heating	Nom.	kW	1.89	2.60	3.72	4.30
EER				3.39	3.87	3.73	3.21
COP				3.97	4.15	3.63	3.61
SEER				5.81 (6)	5.99 (6)	5.69 (6)	-
SCOP				4.13 (6)	3.93 (6)	3.84 (6)	-
Annual energy consumption			kWh	1,005	1,225	1,610	2,085
Energy label	Cooling			A			
	Heating			A			

Notes

- (1) Energy label: scale from A (most efficient) to G (less efficient)
- (2) Annual energy consumption: based on average use of 500 running hours per year at full load (nominal conditions)
- (3) Cooling: indoor temp. 27°CDB, 19°CWB; outdoor temp. 35°CDB, 24°CWB; equivalent piping length: 5m
- (4) Heating: indoor temp. 20°CDB; outdoor temp. 7°CDB, 6°CWB; equivalent refrigerant piping: 5m
- (5) Annual energy consumption is according to Energy labeling directive 2002/31/EC
- (6) SEER and SCOP are according to EN 14825

2 Specifications

2

2-1 Nominal Capacity And Nominal Input				FDQ125C7VEB / RZQG125L7V1B	
Cooling capacity	Nom.		kW	12.0 (3)	
Heating capacity	Nom.		kW	13.5 (4)	
Power input	Cooling	Nom.	kW	3.20	
	Heating	Nom.	kW	3.53	
EER				3.75	
COP				3.83	
SEER				5.61 (6)	
SCOP				4.05 (6)	
Annual energy consumption			kWh	1,600	
Energy label	Cooling			A	
	Heating			A	

Notes

- (1) Energy label: scale from A (most efficient) to G (less efficient)
- (2) Annual energy consumption: based on average use of 500 running hours per year at full load (nominal conditions)
- (3) Cooling: indoor temp. 27°CDB, 19°CWB; outdoor temp. 35°CDB; equivalent piping length: 5m; level difference: 0m
- (4) Heating: indoor temp. 20°CDB; outdoor temp. 7°CDB, 6°CWB; equivalent refrigerant piping: 5m; level difference: 0m
- (5) Annual energy consumption is according to Energy labeling directive 2002/31/EC
- (6) SEER and SCOP are according to EN 14825

2-1 Nominal Capacity And Nominal Input				FAQ71CVEB / RZQG71L7V1B		FAQ100CVEB / RZQG100L7V1B	
Cooling capacity	Nom.		kW	6.8 (3)		9.5 (3)	
Heating capacity	Nom.		kW	7.5 (4)		10.8 (4)	
Power input	Cooling	Nom.	kW	2.00		2.63	
	Heating	Nom.	kW	2.03		3.00	
EER				3.40		3.62	
COP				3.70		3.61	
SEER				5.21 (6)		5.11 (6)	
SCOP				3.9 (6)		4.01 (6)	
Annual energy consumption			kWh	1,000		1,315	
Energy label	Cooling			A		A	
	Heating			A		A	

Notes

- (1) Energy label: scale from A (most efficient) to G (less efficient)
- (2) Annual energy consumption: based on average use of 500 running hours per year at full load (nominal conditions)
- (3) Cooling: indoor temp. 27°CDB, 19.0°CWB; outdoor temp. 35°CDB; equivalent piping length: 5m
- (4) Heating: indoor temp. 20°CDB; outdoor temp. 7°CDB, 6°CWB; equivalent refrigerant piping: 5m
- (5) Annual energy consumption is according to Energy labeling directive 2002/31/EC
- (6) SEER and SCOP are according to EN 14825

2 Specifications

2-1 Nominal Capacity And Nominal Input				FBQ71C8VEB / RZQG71L7V1B	FBQ100C8VEB / RZQG100L7V1B	FBQ125C8VEB / RZQG125L7V1B	FBQ140C8VEB / RZQG140L7V1B
Cooling capacity	Nom.		kW	6.8 (3)	9.5 (3)	12.0 (3)	13.4 (3)
Heating capacity	Nom.		kW	7.5 (4)	10.8 (4)	13.5 (4)	15.5 (4)
Power input	Cooling	Nom.	kW	1.94	2.44	3.15	4.02
	Heating	Nom.	kW	2.05	2.57	3.53	4.30
EER				3.50	3.89	3.81	3.33
COP				3.65	4.21	3.83	3.61
SEER				5.61 (6)			-
SCOP				4.01 (6)	4.25 (6)	4.05 (6)	-
Annual energy consumption			kWh	970	1,220	1,575	2,010
Energy label	Cooling		A				
	Heating		A				

Notes

- (1) Energy label: scale from A (most efficient) to G (less efficient)
- (2) Annual energy consumption: based on average use of 500 running hours per year at full load (nominal conditions)
- (3) Cooling: indoor temp. 27°CDB, 19°CWB; outdoor temp. 35°CDB; equivalent piping length: 5m; level difference: 0m
- (4) Heating: indoor temp. 20°CDB; outdoor temp. 7°CDB, 6°CWB; equivalent refrigerant piping: 5m; level difference: 0m
- (5) Annual energy consumption is according to Energy labeling directive 2002/31/EC
- (6) SEER and SCOP are according to EN 14825

2-1 Nominal Capacity And Nominal Input				FVQ71CVEB / RZQG71L7V1B	FVQ100CVEB / RZQG100L7V1B	FVQ125CVEB / RZQG125L7V1B	FVQ140CVEB / RZQG140L7V1B
Cooling capacity	Nom.		kW	6.8 (3)	9.5 (3)	12.0 (3)	13.4 (3)
Heating capacity	Nom.		kW	7.5 (4)	10.8 (4)	13.5 (4)	15.5 (4)
Power input	Cooling	Nom.	kW	2.02	2.49	3.74	4.17
	Heating	Nom.	kW	2.06	2.61	3.65	4.30
EER				3.37	3.81	3.21	
COP				3.64	4.14	3.70	3.61
SEER				5.16 (6)	5.59 (6)	4.77 (6)	-
SCOP				3.81 (6)	3.80 (6)	3.85 (6)	-
Annual energy consumption			kWh	1,010	1,245	1,870	2,085
Energy label	Cooling		A				
	Heating		A				

Notes

- (1) Energy label: scale from A (most efficient) to G (less efficient)
- (2) Annual energy consumption: based on average use of 500 running hours per year at full load (nominal conditions)
- (3) Cooling: indoor temp. 27°CDB, 19°CWB; outdoor temp. 35°CDB; equivalent piping length: 5m; level difference: 0m
- (4) Heating: indoor temp. 20°CDB; outdoor temp. 7°CDB, 6°CWB; equivalent refrigerant piping: 5m; level difference: 0m
- (5) Annual energy consumption is according to Energy labeling directive 2002/31/EC
- (6) SEER and SCOP are according to EN 14825

2 Specifications

2

2-1 Nominal Capacity And Nominal Input				FHQG71CVEB / RZQG71L7V1B	FHQG100CVEB / RZQG100L7V1B	FHQG125CVEB / RZQG125L7V1B	FHQG140CVEB / RZQG140L7V1B
Cooling capacity	Nom.		kW	6.8 (3)	9.5 (3)	12.0 (3)	13.4 (3)
Heating capacity	Nom.		kW	7.5 (4)	10.8 (4)	13.5 (4)	15.5 (4)
Power input	Cooling	Nom.	kW	1.78	2.49	3.58	4.05
	Heating	Nom.	kW	1.82	2.60	3.48	4.27
EER				3.82	3.81	3.35	3.31
COP				4.13	4.15	3.89	3.63
SEER				5.65 (6)	5.69 (6)	5.11 (6)	-
SCOP				3.95 (6)	4.20 (6)	4.01 (6)	-
Annual energy consumption			kWh	890	1,245	1,790	2,025
Energy label	Cooling			A			
	Heating			A			

Notes

- (1) Energy label: scale from A (most efficient) to G (less efficient)
- (2) Annual energy consumption: based on average use of 500 running hours per year at full load (nominal conditions)
- (3) Cooling: indoor temp. 27°CDB, 19°CWB; outdoor temp. 35°CDB; equivalent piping length: 5m; level difference: 0m
- (4) Heating: indoor temp. 20°CDB; outdoor temp. 7°CDB, 6°CWB; equivalent refrigerant piping: 5m; level difference: 0m
- (5) Annual energy consumption is according to Energy labeling directive 2002/31/EC
- (6) SEER and SCOP are according to EN 14825

2-1 Nominal Capacity And Nominal Input				FUQ71BWV1B / RZQG71L7V1B	FUQ100BWV1B / RZQG100L7V1B	FUQ125BWV1B / RZQG125L7V1B
Cooling capacity	Nom.		kW	6.8 (3)	9.5 (3)	12.0 (3)
Heating capacity	Nom.		kW	7.5 (4)	10.8 (4)	13.5 (4)
Power input	Cooling	Nom.	kW	1.68	2.46	3.54
	Heating	Nom.	kW	1.84	2.73	3.95
EER				4.05	3.86	3.39
COP				4.08	3.95	3.42
SEER				5.65 (6)	4.67 (6)	4.41 (6)
SCOP				3.95 (6)	4.02 (6)	4.09 (6)
Annual energy consumption			kWh	840	1,230	1,770
Energy label	Cooling			A		
	Heating			A		B

Notes

- (1) Energy label: scale from A (most efficient) to G (less efficient)
- (2) Annual energy consumption: based on average use of 500 running hours per year at full load (nominal conditions)
- (3) Cooling: indoor temp. 27°CDB, 19°CWB; outdoor temp. 35°CDB; equivalent piping length: 5m; level difference: 0m
- (4) Heating: indoor temp. 20°CDB; outdoor temp. 7°CDB, 6°CWB; equivalent refrigerant piping: 5m; level difference: 0m
- (5) Annual energy consumption is according to Energy labeling directive 2002/31/EC
- (6) SEER and SCOP are according to EN 14825

2-2 Technical Specifications				RZQG71L7V1	RZQG100L7V1	RZQG125L7V1	RZQG140L7V1
Capacity control	Method			Inverter controlled			
Casing	Colour			Ivory white			
	Material			Painted galvanized steel plate			
Dimensions	Unit	Height	mm	990	1,430		
		Width	mm	940			
		Depth	mm	320			
	Packed unit	Height	mm	1,170	1,610		
		Width	mm	1,015			
		Depth	mm	422			
Weight	Unit		kg	78	102		
	Packed unit		kg	88	115		

2 Specifications

2-2 Technical Specifications					RZQG71L7V1	RZQG100L7V1	RZQG125L7V1	RZQG140L7V1	
Heat exchanger	Length		mm		904				
	Rows	Quantity			2				
	Fin pitch		mm		1.4				
	Passes	Quantity			12	16			
	Face area		m ²		0.87	1.273			
	Stages	Quantity			44	64			
	Empty tubeplate hole	Quantity			0				
	Tube type		ø7 Hi-XSL						
	Fin	Type		WF fin					
Treatment		Anti-corrosion treatment (PE)							
Fan	Type				Propeller fan				
	Discharge direction				Horizontal				
	Quantity				1	2			
	Air flow rate	Cooling	Nom.	m ³ /min	59	70	84		
			Super low	m ³ /min cfm	-				
	Heating	Super low	Nom.	m ³ /min	49	62			
			Super low	m ³ /min cfm	-				
Fan motor	Quantity				1	2			
	Model				Brushless DC motor				
	Output		W		94				
	Drive				Direct drive				
	Speed	Steps			8				
		Cooling	Nom.	rpm	670	600	700		
Super low	rpm		-						
Heating	Nom.	rpm	560	540					
	Super low	rpm	-						
Sound power level	Cooling	Nom.	dBA	64	66	67	69		
Sound pressure level	Cooling	Nom.	dBA	48	50	51	52		
	Heating	Nom.	dBA	50	52	53			
	Night quiet mode	Level 1	dBA	43	45				
Compressor	Quantity				1				
	Model				2YC63SXD	2YC90AXD			
	Type				Hermetically sealed swing compressor				
	Output		W		1,550	2,430	3,100	3,620	
	Starting method				Inverter driven				
Operation range	Cooling	Ambient	Min.	°CDB	-15.0				
			Max.	°CDB	50.0				
	Heating	Ambient	Min.	°CWB	-20.0				
			Max.	°CWB	15.5				
Refrigerant	Type				R-410A				
	Charge		kg		2.9	4.0			
	Control				Expansion valve (electronic type)				
	Circuits	Quantity			1				
Refrigerant oil	Type				FVC50K				
	Charged volume		l		0.9	1.35			

2 Specifications

2-2 Technical Specifications				RZQG71L7V1	RZQG100L7V1	RZQG125L7V1	RZQG140L7V1
Piping connections	Liquid	Quantity		1			
		Type		Flare connection			
		OD	mm	9.52			
	Gas	Quantity		1			
		Type		Flare connection			
		OD	mm	15.9			
	Drain	Quantity		5			
		Type		Hole			
		ID	mm	-			
		OD	mm	26			
	Piping length	OU - IU	Min.	m	5 (5)		
			Max.	m	50	75	
		System	Equivalent	m	70	90	
Chargel ess			m	30			
Additional refrigerant charge			kg/m	see installation manual 4P302555-1			
Level difference	IU - OU	Max.	m	30.0			
	IU - IU	Max.	m	0.5			
Heat insulation			Both liquid and gas pipes				
Defrost method			Pressure equalising				
Defrost control			Sensor for outdoor heat exchanger temperature				
Safety devices	Item	01	High pressure switch				
		02	Fan motor thermal protection				
		03	Fuse				

2-3 Electrical Specifications				RZQG71L7V1	RZQG100L7V1	RZQG125L7V1	RZQG140L7V1
Power supply	Name		V1				
	Phase		1~				
	Frequency	Hz	50				
	Voltage	V	220-240				
	Voltage range	Min.	%	10			
Max.		%	10				
Current	Zmax	List	Complies to EN61000-3-11				
	Recommended fuses		A	25	40		
Wiring connections	For power supply	Remark	see installation manual 4P302555-1				
	For connection with indoor	Remark	see installation manual 4P302555-1				
Power supply intake			Outdoor unit only				

Notes

- (1) Cooling: return air temp. 27°CDB, 19.0°CWB; outdoor temp. 35°CDB; equivalent refrigerant piping length 5m (horizontal)
- (2) Heating rated condition (Return air temperature: 20°CDB, outdoor temperature: 7°CDB, 6°CWB, Equivalent ref.piping:5.0m\<horizontal>, Front 1m, Height 1.5m)
- (3) Minimum piping length: no limit
- (4) PED: assembly = category I : excluded from scope of PED due to article 1, item 3.6 of 97/23/EC
- (5) Equipment complying with EN/IEC 61000-3-12: European/international technical standard setting the limits for harmonic currents produced by equipment connected to public low-voltage system with input current > 16A and ≤ 75A per phase
- (6) Short-circuit power
- (7) See separate drawing for electrical data
- (8) 3 with re-charging

3 Electrical data

3 - 1 Electrical Data

RZQG-L7V1

Indoor	Outdoor	Hz-Power supply	Voltage range	MCA	TOCA	MFA	Comp		OFM		IFM				
							MSC	RLA	kW	FLA	kW	FLA			
FCQHG71FVEB	RZQG71L7V1B	50Hz~220-240V	Min. 198V Max. 264V	18.2	—	20	—	15.6	0.094	0.4	0.091	0.5			
FCQG35FVEB	x2 RZQG71L7V1B			18.4	—	20	—	15.6	0.094	0.4	0.044×2	0.3×2			
FCQG71FVEB	RZQG71L7V1B			18.1	—	20	—	15.6	0.094	0.4	0.054	0.4			
FFQ35B9V1B	x2 RZQG71L7V1B			18.6	—	20	—	15.6	0.094	0.4	0.055×2	0.4×2			
FBQ35C8VEB	x2 RZQG71L7V1B			20.6	—	25	—	15.6	0.094	0.4	0.140×2	1.2×2			
FBQ71C8VEB	RZQG71L7V1B			19.0	—	20	—	15.6	0.094	0.4	0.350	1.1			
FHQ35BWW1B	x2 RZQG71L7V1B			19.1	—	20	—	15.6	0.094	0.4	0.062×2	0.6×2			
FHQG71CVEB	RZQG71L7V1B			18.6	—	20	—	15.6	0.094	0.4	0.091	0.8			
FUQ71BWW1B	RZQG71L7V1B			18.4	—	20	—	15.6	0.094	0.4	0.180	0.6			
FAQ71CVEB	RZQG71L7V1B			18.1	—	20	—	15.6	0.094	0.4	0.048	0.4			
FVQ71CVEB	RZQG71L7V1B			18.4	—	20	—	15.6	0.094	0.4	0.117	0.6			
FCQHG100FVEB	RZQG100L7V1B			50Hz~220-240V	Min. 198V Max. 264V	29.1	—	32	—	24.2	0.094+0.094	0.4+0.4	0.221	1.3	
FCQG35FVEB	x3 RZQG100L7V1B					28.6	—	32	—	24.2	0.094+0.094	0.4+0.4	0.044×3	0.3×3	
FCQG50FVEB	x2 RZQG100L7V1B					28.3	—	32	—	24.2	0.094+0.094	0.4+0.4	0.039×2	0.3×2	
FCQG100FVEB	RZQG100L7V1B					28.4	—	32	—	24.2	0.094+0.094	0.4+0.4	0.117	0.7	
FFQ35B9V1B	x3 RZQG100L7V1B					29.0	—	32	—	24.2	0.094+0.094	0.4+0.4	0.055×3	0.4×3	
FFQ50B9V1B	x2 RZQG100L7V1B	29.3	—			32	—	24.2	0.094+0.094	0.4+0.4	0.055×2	0.7×2			
FBQ35C8VEB	x3 RZQG100L7V1B	32.0	—			40	—	24.2	0.094+0.094	0.4+0.4	0.140×3	1.2×3			
FBQ50C8VEB	x2 RZQG100L7V1B	30.5	—			32	—	24.2	0.094+0.094	0.4+0.4	0.140×2	1.2×2			
FBQ100C8VEB	RZQG100L7V1B	29.5	—			32	—	24.2	0.094+0.094	0.4+0.4	0.350	1.6			
FHQ35BWW1B	x3 RZQG100L7V1B	29.8	—			32	—	24.2	0.094+0.094	0.4+0.4	0.062×3	0.6×3			
FHQ50BWW1B	x2 RZQG100L7V1B	29.0	—			32	—	24.2	0.094+0.094	0.4+0.4	0.062×2	0.6×2			
FHQG100CVEB	RZQG100L7V1B	29.0	—			32	—	24.2	0.094+0.094	0.4+0.4	0.150	1.2			
FUQ100BWW1B	RZQG100L7V1B	28.8	—			32	—	24.2	0.094+0.094	0.4+0.4	0.289	1.0			
FAQ100CVEB	RZQG100L7V1B	28.0	—			32	—	24.2	0.094+0.094	0.4+0.4	0.064	0.4			
FVQ100CVEB	RZQG100L7V1B	29.0	—			32	—	24.2	0.094+0.094	0.4+0.4	0.238	1.2			

3D076356

SYMBOLS

MCA	: Min. Circuit Amps (A)
TOCA	: Total Over Current Amps (A)
MFA	: Max. Fuse Amps (See note 7) (A)
MSC	: Max. current during the starting compressor (A)
RLA	: Rated Load Amps (A)
OFM	: Outdoor Fan Motor (A)
IFM	: Indoor Fan Motor
FLA	: Full Load Amps
kW	: Fan Motor Rated Output (kW)

NOTES

- 1 RLA is based on the following conditions:
Power supply: 50Hz 230V
Cooling
Indoor temperature 27.0°CDB/19.0°CWB
Outdoor temperature 35.0°CDB
Heating
Indoor temperature 20.0°CDB
Outdoor temperature 7.0°CDB/6.0°CWB
- 2 TOCA means the total value of each OC set.
- 3 Voltage range
Units are suitable for use on electrical systems where voltage supplied to unit terminals is not below or above listed range limits
- 4 Maximum allowable voltage variation between phases is 2%.
- 5 MCA represents maximum input current. MFA represents capacity which may accept MCA.
(next lower standard fuse rating, min.15A)
- 6 Select wire size based on the larger value of MCA or TOCA.
- 7 MFA is used to select the circuit breaker and the ground fault circuit interrupter. (earth leakage circuit breaker)

3 Electrical data

3 - 1 Electrical Data

RZQG-L7V1

Indoor	Outdoor	Hz-Power supply	Voltage range	Comp					OFM		IFM	
				MCA	TOCA	MFA	MSC	RLA	kW	FLA	kW	FLA
FCQHG125FVEB	RZQG125L7V1B	50Hz-220-240V	Min. 198V Max. 264V	29.3	—	32	—	24.2	0.094+0.094	0.4+0.4	0.244	1.4
FCQG35FVEB	x4 RZQG125L7V1B			29.0	—	32	—	24.2	0.094+0.094	0.4+0.4	0.044x4	0.3x4
FCQG50FVEB	x3 RZQG125L7V1B			28.6	—	32	—	24.2	0.094+0.094	0.4+0.4	0.039x3	0.3x3
FCQG80FVEB	x2 RZQG125L7V1B			28.3	—	32	—	24.2	0.094+0.094	0.4+0.4	0.044x2	0.3x2
FCQG125FVEB	RZQG125L7V1B			28.8	—	32	—	24.2	0.094+0.094	0.4+0.4	0.168	1.0
FFQ35B9V1B	x4 RZQG125L7V1B			29.5	—	32	—	24.2	0.094+0.094	0.4+0.4	0.055x4	0.4x4
FFQ50B9V1B	x3 RZQG125L7V1B			30.1	—	32	—	24.2	0.094+0.094	0.4+0.4	0.055x3	0.7x3
FFQ60B9V1B	x2 RZQG125L7V1B			29.3	—	32	—	24.2	0.094+0.094	0.4+0.4	0.055x2	0.7x2
FBQ35C8VEB	x4 RZQG125L7V1B			33.5	—	40	—	24.2	0.094+0.094	0.4+0.4	0.140x4	1.2x4
FBQ50C8VEB	x3 RZQG125L7V1B			32.0	—	40	—	24.2	0.094+0.094	0.4+0.4	0.140x3	1.2x3
FBQ60C8VEB	x2 RZQG125L7V1B			30.3	—	32	—	24.2	0.094+0.094	0.4+0.4	0.350x2	1.1x2
FBQ125C8VEB	RZQG125L7V1B			30.1	—	32	—	24.2	0.094+0.094	0.4+0.4	0.350	2.1
FHQ35BWW1B	x4 RZQG125L7V1B			30.5	—	32	—	24.2	0.094+0.094	0.4+0.4	0.062x4	0.6x4
FHQ50BWW1B	x3 RZQG125L7V1B			29.8	—	32	—	24.2	0.094+0.094	0.4+0.4	0.062x3	0.6x3
FHQ60BWW1B	x2 RZQG125L7V1B			29.0	—	32	—	24.2	0.094+0.094	0.4+0.4	0.062x2	0.6x2
FHQG125CVEB	RZQG125L7V1B			29.5	—	32	—	24.2	0.094+0.094	0.4+0.4	0.150	1.6
FUQ125BWW1B	RZQG125L7V1B			28.8	—	32	—	24.2	0.094+0.094	0.4+0.4	0.289	1.0
FDQ125C7VEB	RZQG125L7V1B			30.1	—	32	—	24.2	0.094+0.094	0.4+0.4	0.350	2.1
FVQ125CVEB	RZQG125L7V1B			29.0	—	32	—	24.2	0.094+0.094	0.4+0.4	0.238	1.2
FCQHG71FVEB	x2 RZQG140L7V1B			28.8	—	32	—	24.2	0.094+0.094	0.4+0.4	0.091x2	0.5x2
FCQHG140FVEB	RZQG140L7V1B			29.3	—	32	—	24.2	0.094+0.094	0.4+0.4	0.244	1.4
FCQG35FVEB	x4 RZQG140L7V1B			29.0	—	32	—	24.2	0.094+0.094	0.4+0.4	0.044x4	0.3x4
FCQG50FVEB	x3 RZQG140L7V1B			28.6	—	32	—	24.2	0.094+0.094	0.4+0.4	0.039x3	0.3x3
FCQG71FVEB	x2 RZQG140L7V1B			28.5	—	32	—	24.2	0.094+0.094	0.4+0.4	0.054x2	0.4x2
FCQG140FVEB	RZQG140L7V1B			28.8	—	32	—	24.2	0.094+0.094	0.4+0.4	0.168	1.0
FFQ35B9V1B	x4 RZQG140L7V1B			29.5	—	32	—	24.2	0.094+0.094	0.4+0.4	0.055x4	0.4x4
FFQ50B9V1B	x3 RZQG140L7V1B			30.1	—	32	—	24.2	0.094+0.094	0.4+0.4	0.055x3	0.7x3
FBQ35C8VEB	x4 RZQG140L7V1B			33.5	—	40	—	24.2	0.094+0.094	0.4+0.4	0.140x4	1.2x4
FBQ50C8VEB	x3 RZQG140L7V1B	32.0	—	40	—	24.2	0.094+0.094	0.4+0.4	0.140x3	1.2x3		
FBQ71C8VEB	x2 RZQG140L7V1B	30.3	—	32	—	24.2	0.094+0.094	0.4+0.4	0.350x2	1.1x2		
FBQ140C8VEB	RZQG140L7V1B	30.1	—	32	—	24.2	0.094+0.094	0.4+0.4	0.350	2.1		
FHQ35BWW1B	x4 RZQG140L7V1B	30.5	—	32	—	24.2	0.094+0.094	0.4+0.4	0.062x4	0.6x4		
FHQ50BWW1B	x3 RZQG140L7V1B	29.8	—	32	—	24.2	0.094+0.094	0.4+0.4	0.062x3	0.6x3		
FHQG71CVEB	x2 RZQG140L7V1B	29.5	—	32	—	24.2	0.094+0.094	0.4+0.4	0.091x2	0.8x2		
FHQG140CVEB	RZQG140L7V1B	29.8	—	32	—	24.2	0.094+0.094	0.4+0.4	0.150	1.8		
FUQ71BWW1B	x2 RZQG140L7V1B	29.0	—	32	—	24.2	0.094+0.094	0.4+0.4	0.180x2	0.6x2		
FAQ71CVEB	x2 RZQG140L7V1B	28.5	—	32	—	24.2	0.094+0.094	0.4+0.4	0.048x2	0.4x2		
FVQ140CVEB	RZQG140L7V1B	29.3	—	32	—	24.2	0.094+0.094	0.4+0.4	0.276	1.4		

3D076356

SYMBOLS

- MCA : Min. Circuit Amps (A)
- TOCA : Total Over Current Amps (A)
- MFA : Max. Fuse Amps (See note 7) (A)
- MSC : Max. current during the starting compressor (A)
- RLA : Rated Load Amps (A)
- OFM : Outdoor Fan Motor (A)
- IFM : Indoor Fan Motor
- FLA : Full Load Amps
- kW : Fan Motor Rated Output (kW)

NOTES

- 1 RLA is based on the following conditions:
Power supply: 50Hz 230V
Cooling
Indoor temperature 27.0°CDB/19.0°CWB
Outdoor temperature 35.0°CDB
Heating
Indoor temperature 20.0°CDB
Outdoor temperature 7.0°CDB/6.0°CWB
- 2 TOCA means the total value of each OC set.
- 3 Voltage range
Units are suitable for use on electrical systems where voltage supplied to unit terminals is not below or above listed range limits
- 4 Maximum allowable voltage variation between phases is 2%.
- 5 MCA represents maximum input current. MFA represents capacity which may accept MCA. (next lower standard fuse rating, min.15A)
- 6 Select wire size based on the larger value of MCA or TOCA.
- 7 MFA is used to select the circuit breaker and the ground fault circuit interrupter. (earth leakage circuit breaker)

4 Options

4 - 1 Options

RZQG-L7

Available options for RZQG models:

Name of option	Kit name			
	RZQG71L7V1B	RZQG100L7V1B	RZQG125L7V1B	RZQG140L7V1B
Bottom plate heater	RZQG71L7Y1B	RZQG100L7Y1B	RZQG125L7Y1B	RZQG140L7Y1B
Refrigerant branch piping	Twin	EKBPH140L7: See note 1		
	Triple	KHRQ22M20TA (KHRQ58T): See note 2		
	Double twin	-	KHRQ127H (KHRQ58H): See note 2	
Demand adaptor kit	-	-	KHRQ22M20TA (KHRQ58T): See note 2 (3x)	
			KRP58M51	

3D076079

NOTES

- 1 For combination of RZQG71L7V1B and EKBPH140L7 it is required to use the demand adaptor kit KRP58M51 in order to connect the bottom plate heater.
- 2 For RZQ(S)G71-140L7Y1B in combination with FCQG35-71F or FCQH71F use the refrigerant branch piping mentioned between brackets.

6 Capacity tables

6 - 1 Cooling Capacity Tables

RZQG71L7V1

Cooling

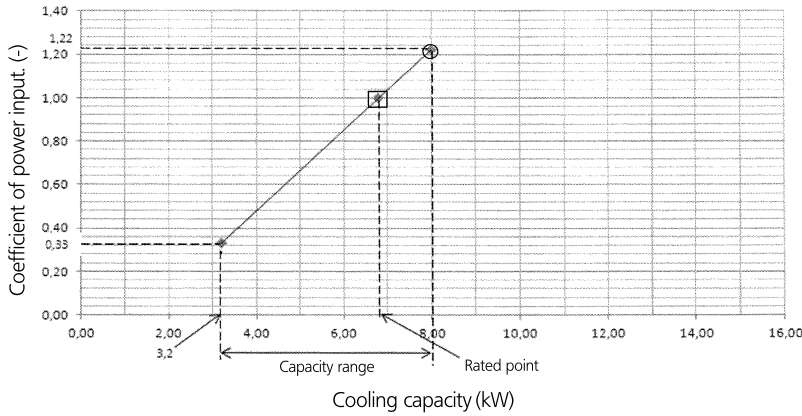

Cooling

Indoor		Outdoor temperature (°CDB)											
		25			30			35			40		
°CWB	°CDB	TC kW	SHC kW	CPI -	TC kW	SHC kW	CPI -	TC kW	SHC kW	CPI -	TC kW	SHC kW	CPI -
16.0	22	8.03	5.45	1.00	7.76	5.32	1.11	7.48	5.20	1.21	7.21	5.06	1.32
18.0	25	8.40	5.45	1.00	8.11	5.32	1.11	7.83	5.19	1.22	7.54	5.05	1.33
19.0	27	8.59	5.44	1.01	8.30	5.32	1.12	8.00	5.18	1.22	7.70	5.05	1.33
19.5	27	8.68	5.43	1.01	8.39	5.31	1.12	8.09	5.17	1.22	7.79	5.05	1.33
22.0	30	9.15	5.38	1.01	8.84	5.25	1.12	8.52	5.13	1.23	8.21	4.99	1.34
24.0	32	9.53	5.31	1.03	9.20	5.19	1.13	8.87	5.06	1.25	8.54	4.92	1.35

NOTES

- Ratings shown are net capacities which include a deduction for indoor fan motor heat.
- On the figure the mark with ○ show the max. at standard conditions.
On the figure the mark with □ show the rated capacity and rated coefficient of power input.
However the max. capacity is not guaranteed, except at standard condition.
- SHC is based on indoor EWB and EDB.
SHC for other dry bulb temp. = SHC + SHC*.
SHC* = SHC correction for other dry bulb.
= 0.02 x AFR (m³/min.) x (1-BF) x (DB*-EDB).
- Capacities are based on the following conditions:
Outdoor air: 85% RH.
However, the condition rated capacity in heating is 7° CDB / 6° CWB.
Corresponding refrigerant piping length: 5.0 m.
Level difference: 0 m.
- Coefficient of power input is the percentage when the rated value is defined as 1.00.
- The value contains less than 5% error according to indoor unit type.
- Heating performance include the drop of frost formation.
- Air flow rate and (BF) are given in table below:

(Pair)

	FCQH71F	FCQ71F	FBQ71C8	FHQ71C	FUQ71B8	FAQ71C	FVQ71C
AFR	21.2	21.5	18	20.5	19	18	18
(BF)	(0.2)	(0.14)	(0.08)	(0.13)	(0.07)	(0.16)	(0.16)

(Twin)

	FCQG35Fx2	FFQ35B9Vx2	FBQ35C8x2	FHQ35B8x2
AFR	12.5x2	10x2	16x2	13x2
(BF)	(0.4x2)	(0.25x2)	(0.15x2)	(0.20x2)

- Rated power input of each model is given in tables below:

(Pair)

	FCQH71F	FCQ71F	FBQ71C8	FHQ71C	FUQ71B8	FAQ71C	FVQ71C
Cooling	1.66	2.01	1.94	1.78	1.68	2.00	2.02

(Twin)

	FCQG35Fx2	FFQ35B9Vx2	FBQ35C8x2	FHQ35B8x2
Cooling	2.04	2.14	1.98	2.38

SYMBOLS

- AFR: Air flow rate (m³/min)
 BF: Bypass factor
 EWB: Entering wet bulb temp. (°CWB)
 EDB: Entering dry bulb temp. (°CDB)
 TC: Maximum Total cooling (heating) capacity (kW)
 SHC: Sensible heat capacity (kW)
 PI: Power input (comp.+indoor and outdoor fan motor)
 CPI: Coefficient of power input. (-)

Caution:
TC and SHC are shown by kW.

3D076748

6 Capacity tables

6 - 1 Cooling Capacity Tables

RZQG100L7V1

Cooling

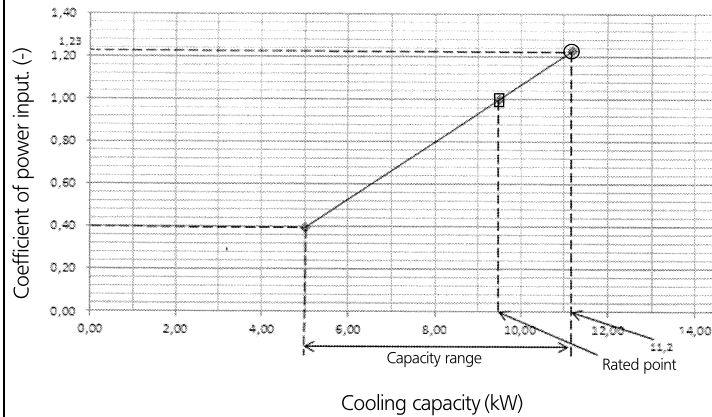

Cooling

Indoor		Outdoor temperature (°CDB)											
		25			30			35			40		
°CWB	°CDB	TC kW	SHC kW	CPI -	TC kW	SHC kW	CPI -	TC kW	SHC kW	CPI -	TC kW	SHC kW	CPI -
16.0	22	11.2	7.61	1.01	10.8	7.44	1.11	10.5	7.29	1.22	10.1	7.09	1.32
18.0	25	11.8	7.59	1.01	11.4	7.49	1.12	11.0	7.27	1.23	10.5	7.09	1.33
19.0	27	12.0	7.57	1.02	11.6	7.44	1.12	11.2	7.26	1.23	10.8	7.04	1.33
19.5	27	12.1	7.59	1.02	11.7	7.37	1.13	11.4	7.34	1.23	10.9	7.04	1.34
22.0	30	12.8	7.52	1.02	12.4	7.36	1.13	11.9	7.16	1.24	11.5	7.03	1.35
24.0	32	13.3	7.42	1.03	12.9	7.27	1.14	12.4	7.06	1.25	12.0	6.91	1.36

NOTES

- Ratings shown are net capacities which include a deduction for indoor fan motor heat.
- On the figure the mark with ○ show the max. at standard conditions. On the figure the mark with □ show the rated capacity and rated coefficient of power input. However the max. capacity is not guaranteed, except at standard condition.
- SHC is based on indoor EWB and EDB. SHC for other dry bulb temp. = SHC + SHC*. SHC* = SHC correction for other dry bulb. = 0.02 x AFR (m³/min.) x (1-BF) x (DB*-EDB).
- Capacities are based on the following conditions:
Outdoor air: 85% RH.
However, the condition rated capacity in heating is 7° CDB / 6° CWB.
Corresponding refrigerant piping length: 5.0 m.
Level difference: 0 m.
- Coefficient of power input is the percentage when the rated value is defined as 1.00.
- The value contains less than 5% error according to indoor unit type.
- Heating performance include the drop of frost formation.
- Air flow rate and (BF) are given in table below:

(Pair)

	FCQHG100F	FCQG100F	FBQ100C8	FHQG100C	FUQ100B8	FAQ100C	FVQ100C
AFR	32.3	32	32	20	29	26	28
(BF)	(0.17)	(0.17)	(0.13)	(0.09)	(0.07)	(0.10)	(0.20)

(Triple)

	FCQG35Fx3	FFQ35B9Vx3	FBQ35C8x3	FHQ35B8x3
AFR	12.5x3	10x3	16x3	13x3
(BF)	(0.4x3)	(0.25x3)	(0.15x3)	(0.20x3)

- Rated power input of each model is given in tables below:

(Pair)

	FCQHG100F	FCQG100F	FBQ100C8	FHQG100C	FUQ100B8	FAQ100C	FVQ100C
Cooling	2.15	2.45	2.44	2.49	2.46	2.63	2.49

(Triple)

	FCQG35Fx3	FFQ35B9Vx3	FBQ35C8x3	FHQ35B8x3
Cooling	2.38	2.44	2.51	2.97

SYMBOLS

- AFR: Air flow rate (m³/min)
 BF: Bypass factor
 EWB: Entering wet bulb temp. (°CWB)
 EDB: Entering dry bulb temp. (°CDB)
 TC: Maximum Total cooling (heating) capacity (kW)
 SHC: Sensible heat capacity (kW)
 PI: Power input (comp.+indoor and outdoor fan motor)
 CPI: Coefficient of power input. (-)

Caution:
TC and SHC are shown by kW.

(Twin)

	FCQG50Fx2	FFQ50B9Vx2	FBQ50C8x2	FHQ50B8x2
AFR	12.6x2	12x2	16x2	13x2
(BF)	(0.22x2)	(0.16x2)	(0.16x2)	(0.10x2)

(Twin)

	FCQG50Fx2	FFQ50B9Vx2	FBQ50C8x2	FHQ50B8x2
Cooling	2.32	2.44	2.51	2.97

3D076749

6 Capacity tables

6 - 1 Cooling Capacity Tables

RZQG125L7V1

Cooling

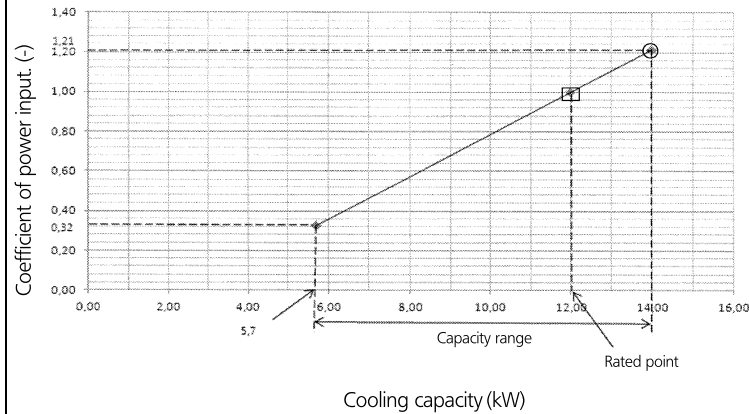

Cooling

Indoor		Outdoor temperature (°CDB)											
		25			30			35			40		
°CWB	°CDB	TC kW	SHC kW	CPI -	TC kW	SHC kW	CPI -	TC kW	SHC kW	CPI -	TC kW	SHC kW	CPI -
16.0	22	14.1	9.54	1.00	13.6	9.30	1.10	13.1	9.12	1.20	12.6	8.78	1.31
18.0	25	14.7	9.50	1.00	14.2	9.32	1.10	13.7	9.09	1.21	13.2	8.83	1.32
19.0	27	15.0	9.52	1.01	14.5	9.34	1.11	14.0	9.06	1.21	13.5	8.87	1.32
19.5	27	15.2	9.52	1.01	14.7	9.26	1.12	14.2	9.08	1.21	13.6	8.81	1.32
22.0	30	16.0	9.39	1.01	15.5	9.14	1.12	14.9	8.95	1.23	14.4	8.74	1.33
24.0	32	16.7	9.31	1.02	16.1	9.09	1.13	15.5	8.83	1.24	15.0	8.63	1.34

NOTES

- Ratings shown are net capacities which include a deduction for indoor fan motor heat.
- On the figure the mark with ○ show the max. at standard conditions.
On the figure the mark with □ show the rated capacity and rated coefficient of power input.
However the max. capacity is not guaranteed, except at standard condition.
- SHC is based on indoor EWB and EDB.
SHC for other dry bulb temp. = SHC + SHC*.
SHC* = SHC correction for other dry bulb.
= 0.02 x AFR (m³/min.) x (1-BF) x (DB*-EDB).
- Capacities are based on the following conditions:
Outdoor air: 85% RH.
However, the condition rated capacity in heating is 7° CDB / 6° CWB.
Corresponding refrigerant piping length: 5.0 m.
Level difference: 0 m.
- Coefficient of power input is the percentage when the rated value is defined as 1.00.
- The value contains less than 5% error according to indoor unit type.
- Heating performance include the drop of frost formation.
- Air flow rate and (BF) are given in table below:

(Pair)

	FCQHG125F	FCQG125F	FBQ125C8	FHQG125C	FUQ125B8	FDQ125C	FVQ125C
AFR	33.5	33	39	31	32	39	28
(BF)	(0.19)	(0.21)	(0.16)	(0.134)	(0.07)	(0.16)	(0.16)

(Triple)

	FCQG50Fx3	FFQ50B9Vx3	FBQ50C8x3	FHQ50B8x3
AFR	12.6x3	12x3	16x3	13x3
(BF)	(0.22x3)	(0.16x3)	(0.16x3)	(0.10x3)

- Rated power input of each model is given in tables below:

(Pair)

	FCQHG125F	FCQG125F	FBQ125C8	FHQG125C	FUQ125B8	FDQ125C	FVQ125C
Cooling	3.00	3.22	3.15	3.58	3.54	3.20	3.74

(Triple)

	FCQG50Fx3	FFQ50B9Vx3	FBQ50C8x3	FHQ50B8x3
Cooling	3.17	3.41	3.28	3.72

SYMBOLS

- AFR: Air flow rate (m³/min)
- BF: Bypass factor
- EWB: Entering wet bulb temp. (°CWB)
- EDB: Entering dry bulb temp. (°CDB)
- TC: Maximum Total cooling (heating) capacity (kW)
- SHC: Sensible heat capacity (kW)
- PI: Power input (comp.+indoor and outdoor fan motor)
- CPI: Coefficient of power input. (-)

Caution:
TC and SHC are shown by kW.

(Twin)

	FCQG60Fx2	FFQ60B9Vx2	FBQ60C8x2	FHQ60B8x2
AFR	13.6x2	15x2	18x2	17x2
(BF)	(0.2x2)	(0.11x2)	(0.15x2)	(0.20x2)

(Double twin)

	FCQG35Fx4	FFQ35B9Vx4	FBQ35C8x4	FHQ35B8x4
AFR	12.5x4	10x4	16x4	13x4
(BF)	(0.4x4)	(0.25x4)	(0.15x4)	(0.20x4)

(Twin)

	FCQG60Fx2	FFQ60B9Vx2	FBQ60C8x2	FHQ60B8x2
Cooling	3.14	3.41	3.28	3.72

(Double twin)

	FCQG35Fx4	FFQ35B9Vx4	FBQ35C8x4	FHQ35B8x4
Cooling	3.23	3.41	3.28	3.72

3D076750

6 Capacity tables

6 - 1 Cooling Capacity Tables

RZQG140L7V1

Cooling

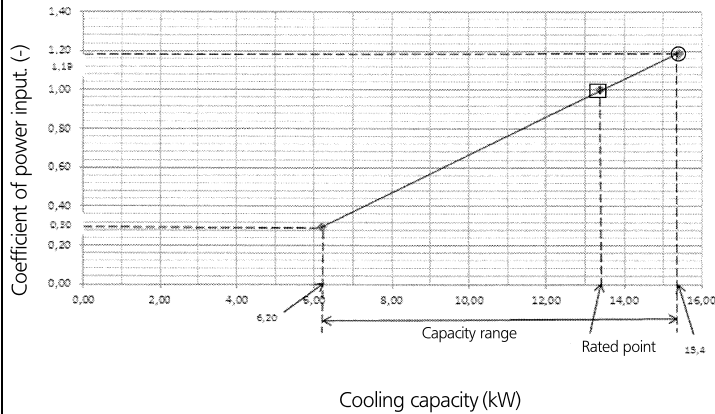

Cooling

Indoor		Outdoor temperature (°CDB)											
		25			30			35			40		
°CWB	°CDB	TC kW	SHC kW	CPI -	TC kW	SHC kW	CPI -	TC kW	SHC kW	CPI -	TC kW	SHC kW	CPI -
16.0	22	15.5	10.47	0.98	14.9	10.25	1.08	14.4	10.08	1.18	13.9	9.69	1.28
18.0	25	16.2	10.55	0.98	15.6	10.21	1.09	15.1	10.01	1.19	14.5	9.71	1.30
19.0	27	16.6	10.43	0.99	16.0	10.18	1.09	15.4	9.98	1.19	14.8	9.76	1.30
19.5	27	16.7	10.49	0.99	16.1	10.16	1.10	15.6	10.00	1.19	15.0	9.66	1.30
22.0	30	17.6	10.37	0.99	17.0	10.16	1.10	16.4	9.83	1.21	15.8	9.60	1.31
24.0	32	18.4	10.20	1.00	17.7	10.00	1.11	17.0	9.67	1.22	16.4	9.47	1.32

NOTES

- Ratings shown are net capacities which include a deduction for indoor fan motor heat.
- On the figure the mark with ○ show the max. at standard conditions.
On the figure the mark with □ show the rated capacity and rated coefficient of power input.
However the max. capacity is not guaranteed, except at standard condition.
- SHC is based on indoor EWB and EDB.
SHC* for other dry bulb temp. = SHC + SHC*.
SHC* = SHC correction for other dry bulb.
= 0.02 x AFR (m³/min.) x (1-BF) x (DB*-EDB).
- Capacities are based on the following conditions:
Outdoor air: 85% RH.
However, the condition rated capacity in heating is 7° CDB / 6° CWB.
Corresponding refrigerant piping length: 5.0 m.
Level difference: 0 m.
- Coefficient of power input is the percentage when the rated value is defined as 1.00.
- The value contains less than 5% error according to indoor unit type.
- Heating performance include the drop of frost formation.
- Air flow rate and (BF) are given in table below:

SYMBOLS

- AFR: Air flow rate (m³/min)
 BF: Bypass factor
 EWB: Entering wet bulb temp. (°CWB)
 EDB: Entering dry bulb temp. (°CDB)
 TC: Maximum Total cooling (heating) capacity (kW)
 SHC: Sensible heat capacity (kW)
 PI: Power input (comp.+indoor and outdoor fan motor)
 CPI: Coefficient of power input. (-)

Caution:
TC and SHC are shown by kW.

(Pair)

	FCQHG140F	FCQG140F	FBQ140C8	FHQG140C	FVQ140C
AFR	33.5	33	39	34	30
(BF)	(0.15)	(0.23)	(0.14)	(0.17)	(0.18)

(Twin)

	FCQG71Fx2	FCQG71Fx2	FBQ71C8x2	FHQG71Cx2	FAQ71Cx2	FUQ71B8x2
AFR	21.2x2	21.5x2	18x2	20.5x2	18x2	19x2
(BF)	(0.2x2)	(0.14x2)	(0.08x2)	(0.13x2)	(0.16x2)	(0.07x2)

(Triple)

	FCQG50Fx3	FFQ50B9Vx3	FBQ50C8x3	FHQ50B8x3
AFR	12.6x3	12x3	16x3	13x3
(BF)	(0.22x3)	(0.16x3)	(0.16x3)	(0.10x3)

(Double twin)

	FCQG35Fx4	FFQ35B9Vx4	FBQ35C8x4	FHQ35B8x4
AFR	12.5x4	10x4	16x4	13x4
(BF)	(0.4x4)	(0.25x4)	(0.15x4)	(0.20x4)

- Rated power input of each model is given in tables below:

(Pair)

	FCQHG140F	FCQG140F	FBQ140C8	FHQG140C	FVQ140C
Cooling	4.00	4.17	4.02	4.05	4.17

(Twin)

	FHQG71Fx2	FCQG71Fx2	FBQ71C8x2	FHQG71C8x2	FAQ71Cx2	FUQ71B8x2
Cooling	3.94	4.11	3.75	3.59	3.81	3.49

(Triple)

	FCQG50Fx3	FFQ50B9Vx3	FBQ50C8x3	FHQ50B8x3
Cooling	4.12	4.20	3.75	4.31

(Double twin)

	FCQG35Fx4	FFQ35B9Vx4	FBQ35C8x4	FHQ35B8x4
Cooling	4.18	4.20	3.75	4.31

3D076751

6 Capacity tables

6 - 2 Heating Capacity Tables

RZQG71L7V1

Heating

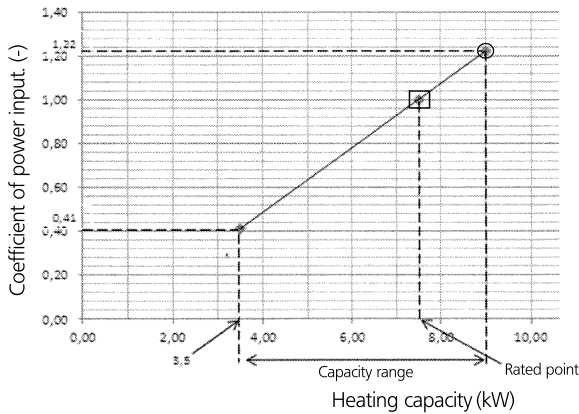

Heating

Indoor °CDB	Outdoor temperature (°CWB)											
	-15.0		-10.0		-5.0		0.0		6.0		10.0	
	TC kW	CPI	TC kW	CPI	TC kW	CPI	TC kW	CPI	TC kW	CPI	TC kW	CPI
16	6.49	1.83	7.09	1.93	7.53	2.01	7.81	2.07	9.00	1.13	9.71	1.19
18	6.48	1.91	7.07	2.01	7.52	2.09	7.80	2.15	9.00	1.17	9.71	1.23
20	6.47	1.99	7.07	2.09	7.51	2.17	7.79	2.23	9.00	1.22	9.71	1.28
21	6.47	2.03	7.07	2.13	7.51	2.21	7.79	2.28	9.00	1.24	9.71	1.31
22	6.46	2.06	7.06	2.17	7.50	2.25	7.78	2.32	9.00	1.27	9.71	1.33
24	6.46	2.14	7.05	2.25	7.49	2.33	7.78	2.40	9.00	1.31	9.67	1.38

NOTES

- Ratings shown are net capacities which include a deduction for indoor fan motor heat.
- On the figure the mark with \square show the max. at standard conditions.
On the figure the mark with \circ show the rated capacity and rated coefficient of power input.
However the max. capacity is not guaranteed, except at standard condition.
- SHC is based on indoor EWB and EDB.
SHC for other dry bulb temp. = SHC + SHC*.
SHC* = SHC correction for other dry bulb.
= $0.02 \times \text{AFR} (\text{m}^3/\text{min}) \times (1 - \text{BF}) \times (\text{DB}^* - \text{EDB})$.
- Capacities are based on the following conditions:
Outdoor air: 85% RH.
However, the condition rated capacity in heating is 7° CDB / 6° CWB.
Corresponding refrigerant piping length: 5.0 m.
Level difference: 0 m.
- Coefficient of power input is the percentage when the rated value is defined as 1.00.
- The value contains less than 5% error according to indoor unit type.
- Heating performance include the drop of frost formation.
- Air flow rate and (BF) are given in table below:

(Pair)

	FCQH71F	FCQ71F	FBQ71C8	FHQ71C	FUQ71B8	FAQ71C	FVQ71C
AFR	21.2	21.5	18	20.5	19	18	18
(BF)	(0.2)	(0.14)	(0.08)	(0.13)	(0.07)	(0.16)	(0.16)

(Twin)

	FCQG35Fx2	FFQ35B9Vx2	FBQ35C8x2	FHQ35B8x2
AFR	12.5x2	10x2	16x2	13x2
(BF)	(0.4x2)	(0.25x2)	(0.15x2)	(0.20x2)

- Rated power input of each model is given in tables below:

(Pair)

	FCQH71F	FCQ71F	FBQ71C8	FHQ71C	FUQ71B8	FAQ71C	FVQ71C
Heating	1.56	1.89	2.05	1.82	1.84	2.03	2.06

(Twin)

	FCQG35Fx2	FFQ35B9Vx2	FBQ35C8x2	FHQ35B8x2
Heating	1.92	2.61	2.16	2.78

SYMBOLS

- AFR: Air flow rate (m³/min)
- BF: Bypass factor
- EWB: Entering wet bulb temp. (°CWB)
- EDB: Entering dry bulb temp. (°CDB)
- TC: Maximum Total cooling (heating) capacity (kW)
- SHC: Sensible heat capacity (kW)
- PI: Power input (comp.+indoor and outdoor fan motor)
- CPI: Coefficient of power input. (-)

Caution:
TC and SHC are shown by kW.

3D076748

6 Capacity tables

6 - 2 Heating Capacity Tables

RZQG100L7V1

Heating

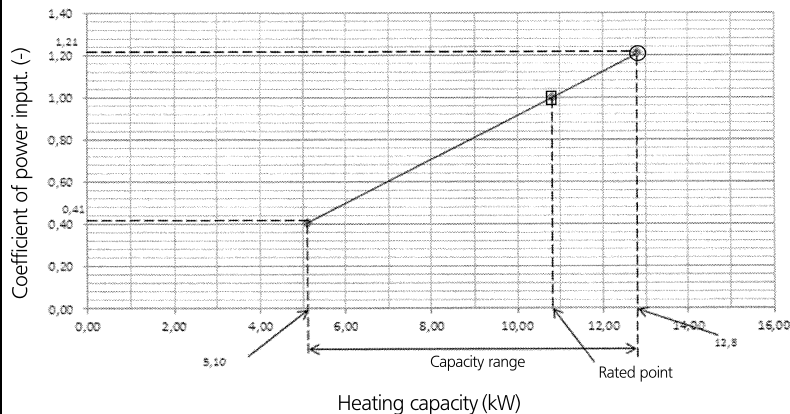

Heating

Indoor °CDB	Outdoor temperature (°CWB)											
	-15.0		-10.0		-5.0		0.0		6.0		10.0	
	TC kW	CPI -	TC kW	CPI -	TC kW	CPI -	TC kW	CPI -	TC kW	CPI -	TC kW	CPI -
16	8.66	1.60	9.61	1.69	10.2	1.76	10.4	1.81	12.8	1.12	13.8	1.17
18	8.65	1.66	9.61	1.76	10.2	1.83	10.4	1.89	12.8	1.16	13.8	1.22
20	8.63	1.73	9.60	1.83	10.2	1.90	10.4	1.96	12.8	1.21	13.8	1.27
21	8.63	1.77	9.59	1.86	10.2	1.94	10.4	2.00	12.8	1.23	13.8	1.29
22	8.62	1.80	9.59	1.90	10.2	1.97	10.4	2.03	12.8	1.25	13.8	1.32
24	8.62	1.87	9.58	1.97	10.2	2.05	10.4	2.11	12.8	1.30	13.8	1.37

NOTES

- Ratings shown are net capacities which include a deduction for indoor fan motor heat.
- On the figure the mark with ○ show the max. at standard conditions.
On the figure the mark with □ show the rated capacity and rated coefficient of power input.
However the max. capacity is not guaranteed, except at standard condition.
- SHC is based on indoor EWB and EDB.
SHC for other dry bulb temp. = SHC + SHC*.
SHC* = SHC correction for other dry bulb.
= 0.02 x AFR (m³/min.) x (1-BF) x (DB*-EDB).
- Capacities are based on the following conditions:
Outdoor air: 85% RH.
However, the condition rated capacity in heating is 7° CDB / 6° CWB.
Corresponding refrigerant piping length: 5.0 m.
Level difference: 0 m.
- Coefficient of power input is the percentage when the rated value is defined as 1.00.
- The value contains less than 5% error according to indoor unit type.
- Heating performance include the drop of frost formation.
- Air flow rate and (BF) are given in table below:

(Pair)

	FCQHG100F	FCQG100F	FBQ100C8	FHQG100C	FUQ100B8	FAQ100C	FVQ100C
AFR	32.3	32	32	20	29	26	28
(BF)	(0.17)	(0.17)	(0.13)	(0.09)	(0.07)	(0.10)	(0.20)

(Triple)

	FCQG35Fx3	FFQ35B9Vx3	FBQ35C8x3	FHQ35B8x3
AFR	12.5x3	10x3	16x3	13x3
(BF)	(0.4x3)	(0.25x3)	(0.15x3)	(0.20x3)

- Rated power input of each model is given in tables below:

(Pair)

	FCQHG100F	FCQG100F	FBQ100C8	FHQG100C	FUQ100B8	FAQ100C	FVQ100C
Heating	2.16	2.60	2.57	2.60	2.73	3.00	2.61

(Triple)

	FCQG35Fx2	FFQ35B9Vx2	FBQ35C8x2	FHQ35B8x2
Heating	2.51	2.79	2.86	3.32

SYMBOLS

- AFR: Air flow rate (m³/min)
 BF: Bypass factor
 EWB: Entering wet bulb temp. (°CWB)
 EDB: Entering dry bulb temp. (°CDB)
 TC: Maximum Total cooling (heating) capacity (kW)
 SHC: Sensible heat capacity (kW)
 PI: Power input (comp.+indoor and outdoor fan motor)
 CPI: Coefficient of power input. (-)

Caution:
TC and SHC are shown by kW.

(Twin)

	FCQG50Fx2	FFQ50B9Vx2	FBQ50C8x2	FHQ50B8x2
AFR	12.6x2	12x2	16x2	13x2
(BF)	(0.22x2)	(0.16x2)	(0.16x2)	(0.10x2)

(Twin)

	FCQG50Fx2	FFQ50B9Vx2	FBQ50C8x2	FHQ50B8x2
Heating	2.46	2.79	2.86	3.32

3D076749

6 Capacity tables

6 - 2 Heating Capacity Tables

RZQG125L7V1

Heating

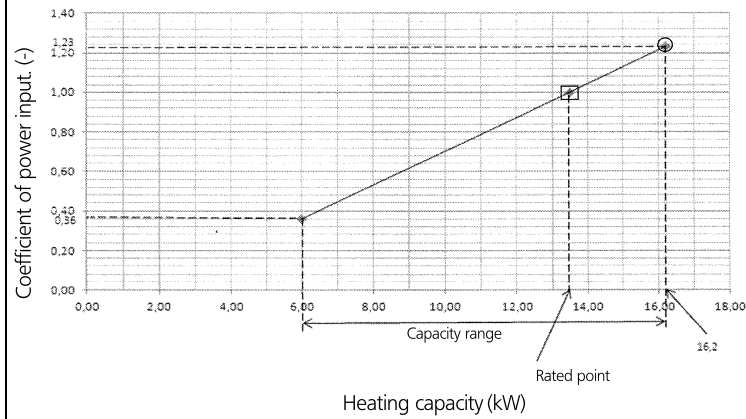

Heating

Indoor °CDB	Outdoor temperature (°CWB)											
	-15.0		-10.0		-5.0		0.0		6.0		10.0	
	TC kW	CPI	TC kW	CPI	TC kW	CPI	TC kW	CPI	TC kW	CPI	TC kW	CPI
16	11.1	1.60	12.1	1.70	12.8	1.77	13.3	1.82	16.2	1.14	17.5	1.20
18	11.1	1.67	12.1	1.77	12.8	1.84	13.3	1.90	16.2	1.18	17.5	1.24
20	11.0	1.74	12.0	1.84	12.8	1.91	13.3	1.97	16.2	1.23	17.5	1.29
21	11.0	1.78	12.0	1.87	12.8	1.95	13.3	2.01	16.2	1.25	17.5	1.32
22	11.0	1.81	12.0	1.91	12.8	1.98	13.3	2.04	16.2	1.28	17.4	1.34
24	11.0	1.88	12.0	1.98	12.8	2.06	13.3	2.12	16.2	1.32	17.4	1.39

NOTES

- Ratings shown are net capacities which include a deduction for indoor fan motor heat.
- On the figure the mark with ○ show the max. at standard conditions.
On the figure the mark with □ show the rated capacity and rated coefficient of power input.
However the max. capacity is not guaranteed, except at standard condition.
- SHC is based on indoor EWB and EDB.
SHC for other dry bulb temp. = SHC + SHC*
SHC* = SHC correction for other dry bulb.
= 0.02 x AFR (m³/min.) x (1-BF) x (DB*-EDB).
- Capacities are based on the following conditions:
Outdoor air: 85% RH.
However, the condition rated capacity in heating is 7° CDB / 6° CWB.
Corresponding refrigerant piping length: 5.0 m.
Level difference: 0 m.
- Coefficient of power input is the percentage when the rated value is defined as 1.00.
- The value contains less than 5% error according to indoor unit type.
- Heating performance include the drop of frost formation.
- Air flow rate and (BF) are given in table below:

(Pair)

	FCQHG125F	FCQG125F	FBQ125C8	FHQG125C	FUQ125B8	FDQ125C	FVQ125C
AFR	33.5	33	39	31	32	39	28
(BF)	(0.19)	(0.21)	(0.16)	(0.134)	(0.07)	(0.16)	(0.16)

(Triple)

	FCQG50Fx3	FFQ50B9Vx3	FBQ50C8x3	FHQ50B8x3
AFR	12.6x3	12x3	16x3	13x3
(BF)	(0.22x3)	(0.16x3)	(0.16x3)	(0.10x3)

- Rated power input of each model is given in tables below:

(Pair)

	FCQHG125F	FCQG125F	FBQ125C8	FHQG125C	FUQ125B8	FDQ125C	FVQ125C
Heating	3.07	3.72	3.53	3.48	3.95	3.53	3.65

(Triple)

	FCQG50Fx3	FFQ50B9Vx3	FBQ50C8x3	FHQ50B8x3
Heating	3.66	3.83	3.74	4.16

SYMBOLS

- AFR: Air flow rate (m³/min)
 BF: Bypass factor
 EWB: Entering wet bulb temp. (°CWB)
 EDB: Entering dry bulb temp. (°CDB)
 TC: Maximum Total cooling (heating) capacity (kW)
 SHC: Sensible heat capacity (kW)
 PI: Power input (comp.-indoor and outdoor fan motor)
 CPI: Coefficient of power input. (-)

Caution:
TC and SHC are shown by kW.

(Twin)

	FCQG60Fx2	FFQ60B9Vx2	FBQ60C8x2	FHQ60B8x2
AFR	13.6x2	15x2	18x2	17x2
(BF)	(0.2x2)	(0.11x2)	(0.15x2)	(0.20x2)

(Double twin)

	FCQG35Fx4	FFQ35B9Vx4	FBQ35C8x4	FHQ35B8x4
AFR	12.5x4	10x4	16x4	13x4
(BF)	(0.4x4)	(0.25x4)	(0.15x4)	(0.20x4)

(Twin)

	FCQG60Fx2	FFQ60B9Vx2	FBQ60C8x2	FHQ60B8x2
Heating	3.64	3.83	3.74	4.16

(Double twin)

	FCQG35Fx4	FFQ35B9Vx4	FBQ35C8x4	FHQ35B8x4
Heating	3.72	3.83	3.74	4.16

3D076750

6 Capacity tables

6 - 2 Heating Capacity Tables

RZQG140L7V1

Heating

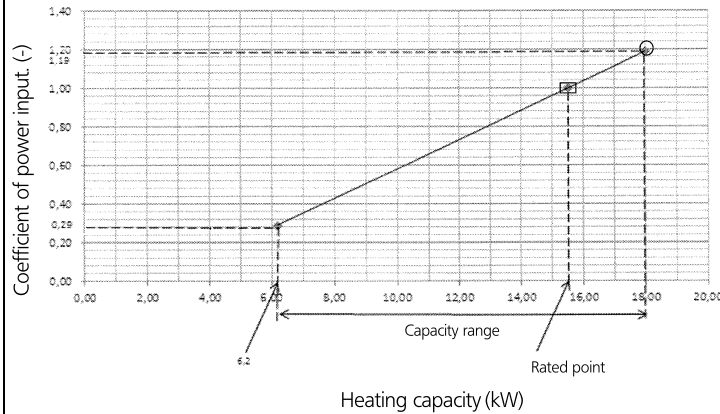

Heating

Indoor °CDB	Outdoor temperature (°CWB)											
	-15.0		-10.0		-5.0		0.0		6.0		10.0	
	TC kW	CPI	TC kW	CPI	TC kW	CPI	TC kW	CPI	TC kW	CPI	TC kW	CPI
16	11.6	1.46	12.7	1.53	13.5	1.59	14.0	1.63	18.0	1.10	19.4	1.16
18	11.6	1.52	12.7	1.59	13.5	1.65	14.0	1.70	18.0	1.14	19.4	1.21
20	11.6	1.55	12.7	1.64	13.5	1.71	14.0	1.77	18.0	1.19	19.4	1.25
21	11.6	1.59	12.7	1.68	13.5	1.75	14.0	1.80	18.0	1.22	19.4	1.28
22	11.6	1.62	12.7	1.71	13.5	1.78	14.0	1.83	18.0	1.24	19.4	1.30
24	11.6	1.68	12.6	1.77	13.4	1.84	14.0	1.90	18.0	1.29	19.4	1.35

NOTES

- Ratings shown are net capacities which include a deduction for indoor fan motor heat.
- On the figure the mark with ○ show the max. at standard conditions.
On the figure the mark with □ show the rated capacity and rated coefficient of power input.
However the max. capacity is not guaranteed, except at standard condition.
- SHC is based on indoor EWB and EDB.
SHC for other dry bulb temp. = SHC + SHC*.
SHC* = SHC correction for other dry bulb.
= 0.02 x AFR (m³/min.) x (1-BF) x (DB*-EDB).
- Capacities are based on the following conditions:
Outdoor air: 85% RH.
However, the condition rated capacity in heating is 7° CDB / 6° CWB.
Corresponding refrigerant piping length: 5.0 m.
Level difference: 0 m.
- Coefficient of power input is the percentage when the rated value is defined as 1.00.
- The value contains less than 5% error according to indoor unit type.
- Heating performance include the drop of frost formation.
- Air flow rate and (BF) are given in table below:

(Pair)

	FCQHG140F	FCQG140F	FBQ140C8	FHQG140C	FVQ140C
AFR	33.5	33	41	34	30
(BF)	(0.15)	(0.23)	(0.14)	(0.17)	(0.18)

(Triple)

	FCQG50Fx3	FFQ50B9Vx3	FBQ50C8x3	FHQ50B8x3
AFR	12.6x3	12x3	16x3	13x3
(BF)	(0.22x3)	(0.16x3)	(0.16x3)	(0.10x3)

- Rated power input of each model is given in tables below:

(Pair)

	FCQHG140F	FCQG140F	FBQ140C8	FHQG140C	FVQ140C
Heating	3.77	4.30	4.30	4.27	4.30

(Triple)

	FCQG50Fx3	FFQ50B9Vx3	FBQ50C8x3	FHQ50B8x3
Heating	4.24	4.92	4.70	5.49

SYMBOLS

- AFR: Air flow rate (m³/min)
 BF: Bypass factor
 EWB: Entering wet bulb temp. (°CWB)
 EDB: Entering dry bulb temp. (°CDB)
 TC: Maximum Total cooling (heating) capacity (kW)
 SHC: Sensible heat capacity (kW)
 PI: Power input (comp.+indoor and outdoor fan motor)
 CPI: Coefficient of power input. (-)

Caution:
TC and SHC are shown by kW.

(Twin)

	FCQHG71Fx2	FCQG71Fx2	FBQ71C8x2	FHQG71Cx2	FAQ71Cx2	FUQ71B8x2
AFR	21.2x2	21.5x2	18x2	20.5x2	18x2	19x2
(BF)	(0.2x2)	(0.14x2)	(0.08x2)	(0.13x2)	(0.16x2)	(0.07x2)

(Double twin)

	FCQG35Fx4	FFQ35B9Vx4	FBQ35C8x4	FHQ35B8x4
AFR	12.5x4	10x4	16x4	13x4
(BF)	(0.4x4)	(0.25x4)	(0.15x4)	(0.20x4)

(Twin)

	FCQHG71Fx2	FCQG71Fx2	FBQ71C8x2	FHQG71C8x2	FAQ71Cx2	FUQ71B8x2
Heating	3.71	4.24	4.70	4.47	4.68	4.47

(Double twin)

	FCQG35Fx4	FFQ35B9Vx4	FBQ35C8x4	FHQ35B8x4
Heating	4.30	4.92	4.70	5.49

3D076751

6 Capacity tables

6 - 3 Capacity Correction Factor

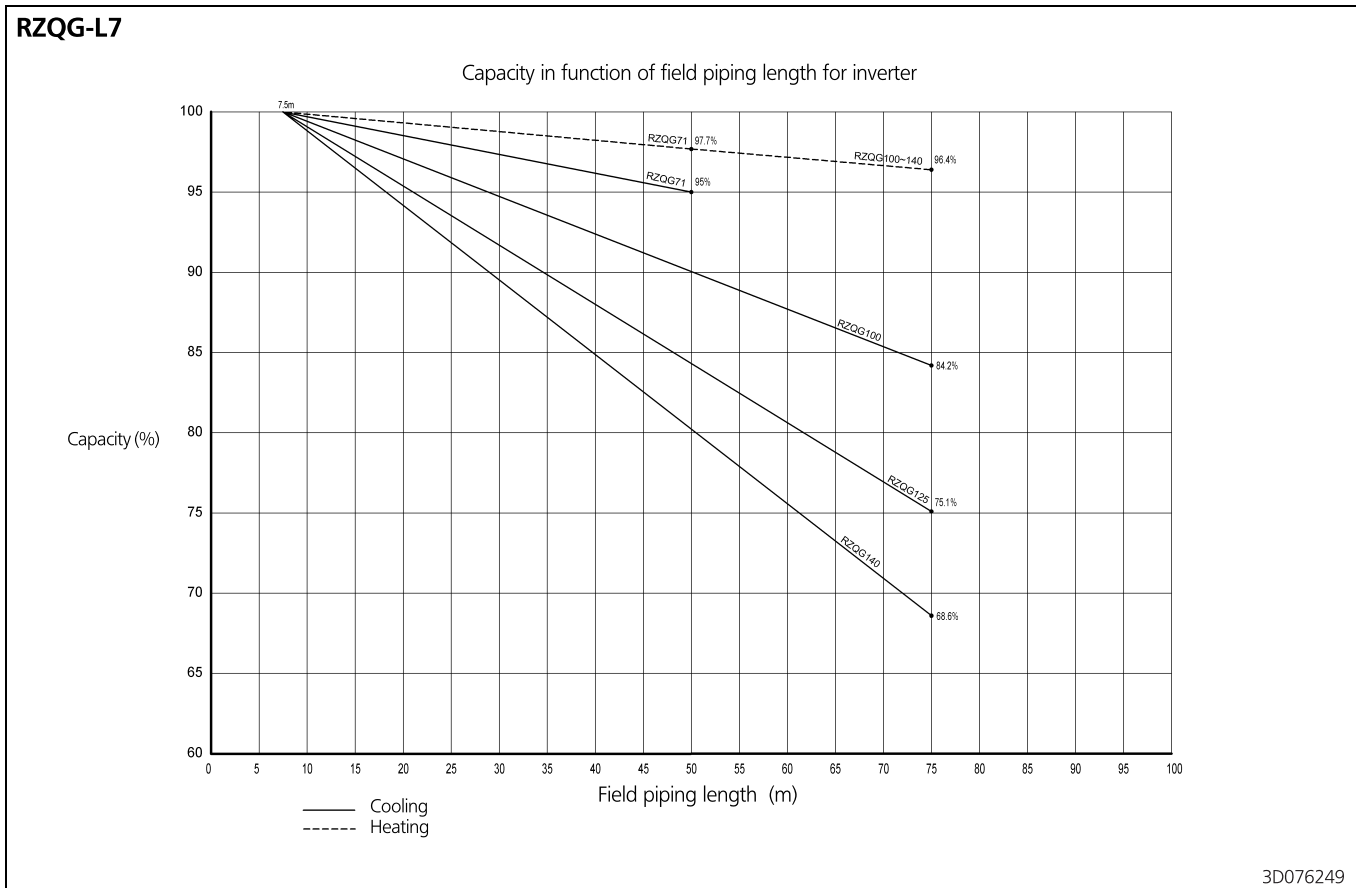

7 Dimensional drawings

7 - 1 Dimensional Drawings

7

RZQG71L7V1

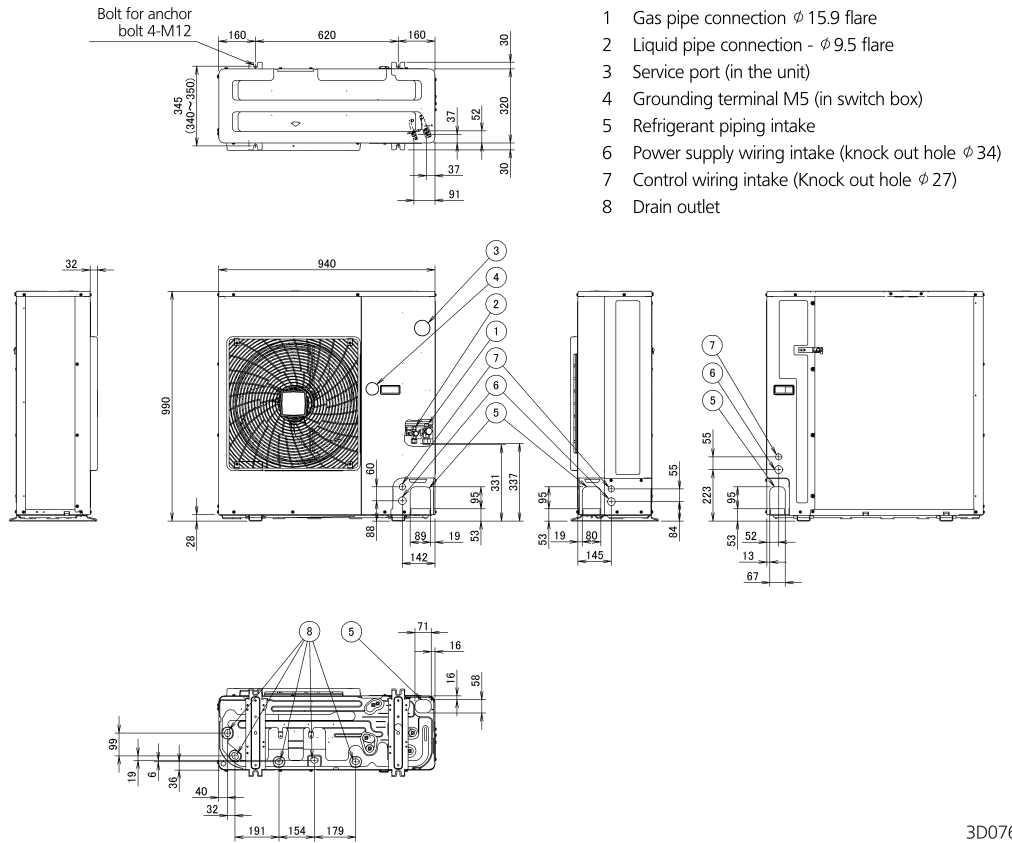

3D076345

RZQG100-140L7V1

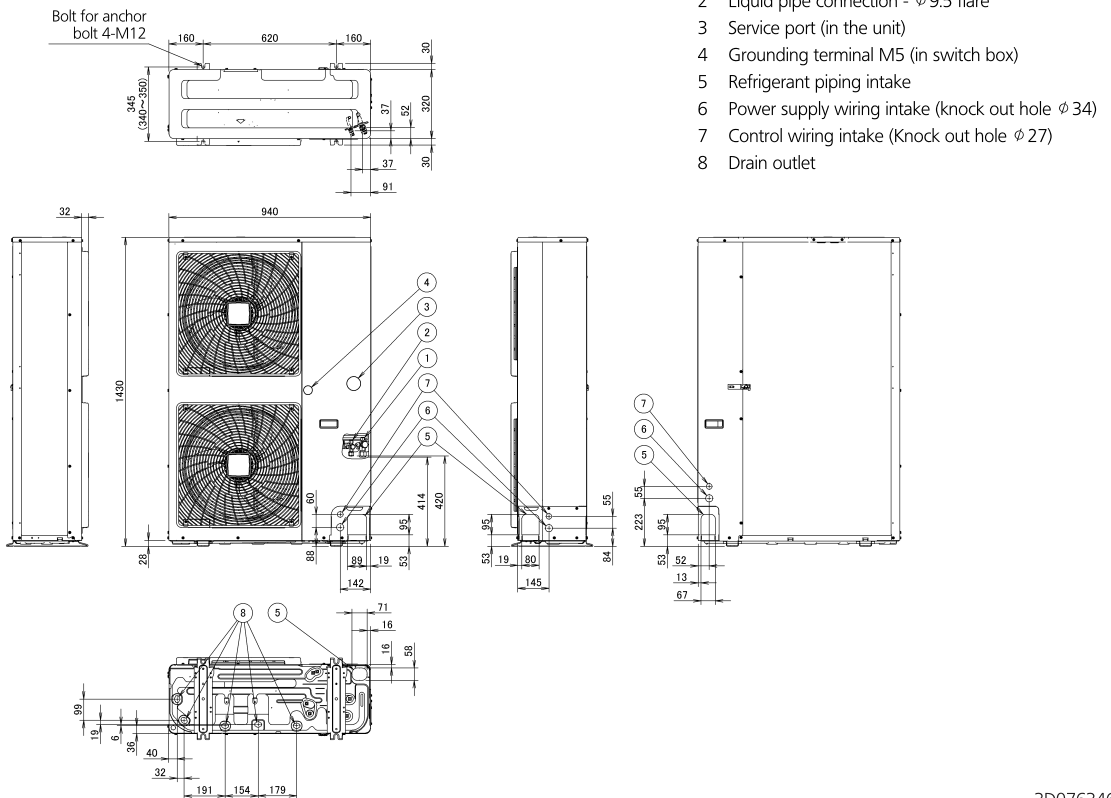

3D076346

8 Centre of gravity

8 - 1 Centre of Gravity

RZQG71L7V1

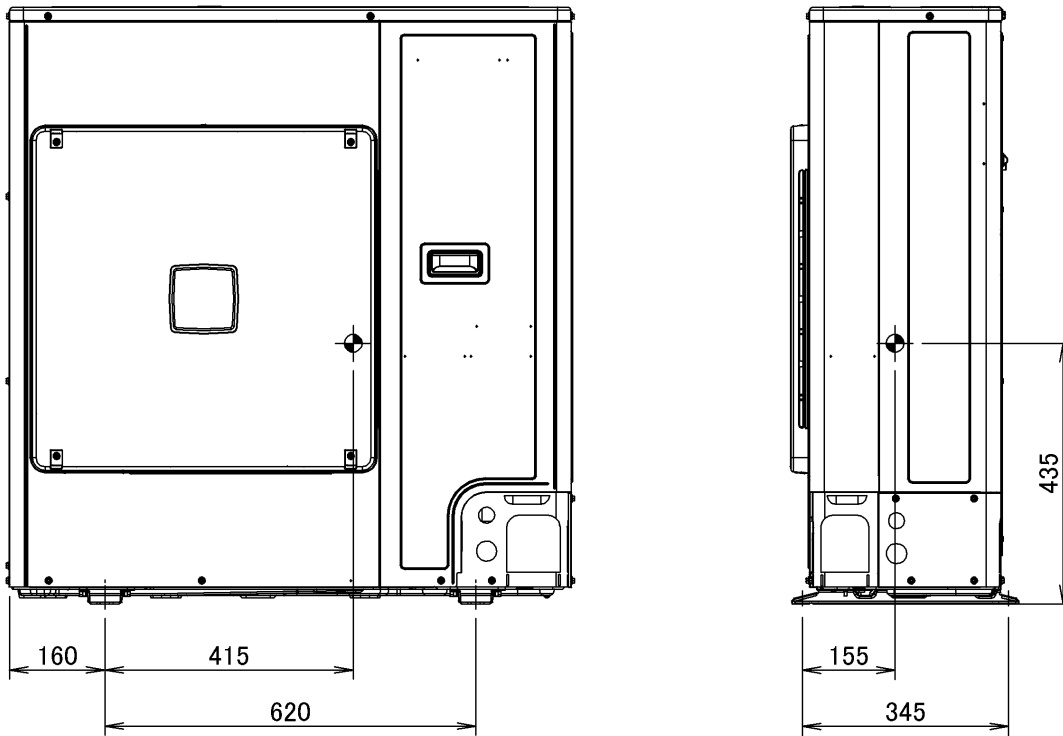

4D076236

RZQG100-140L7V1

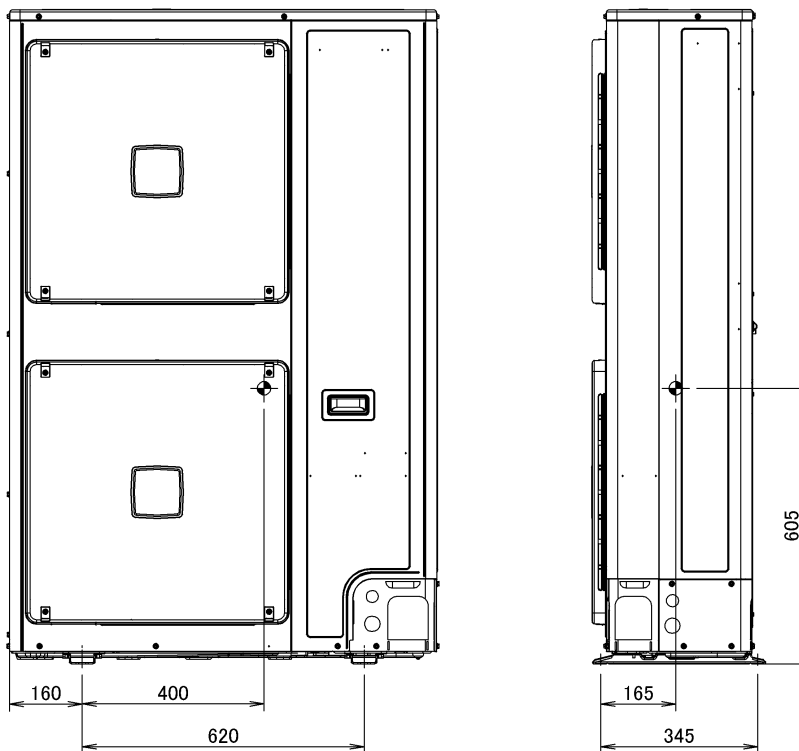

4D076248

9 Piping diagrams

9 - 1 Piping Diagram

9

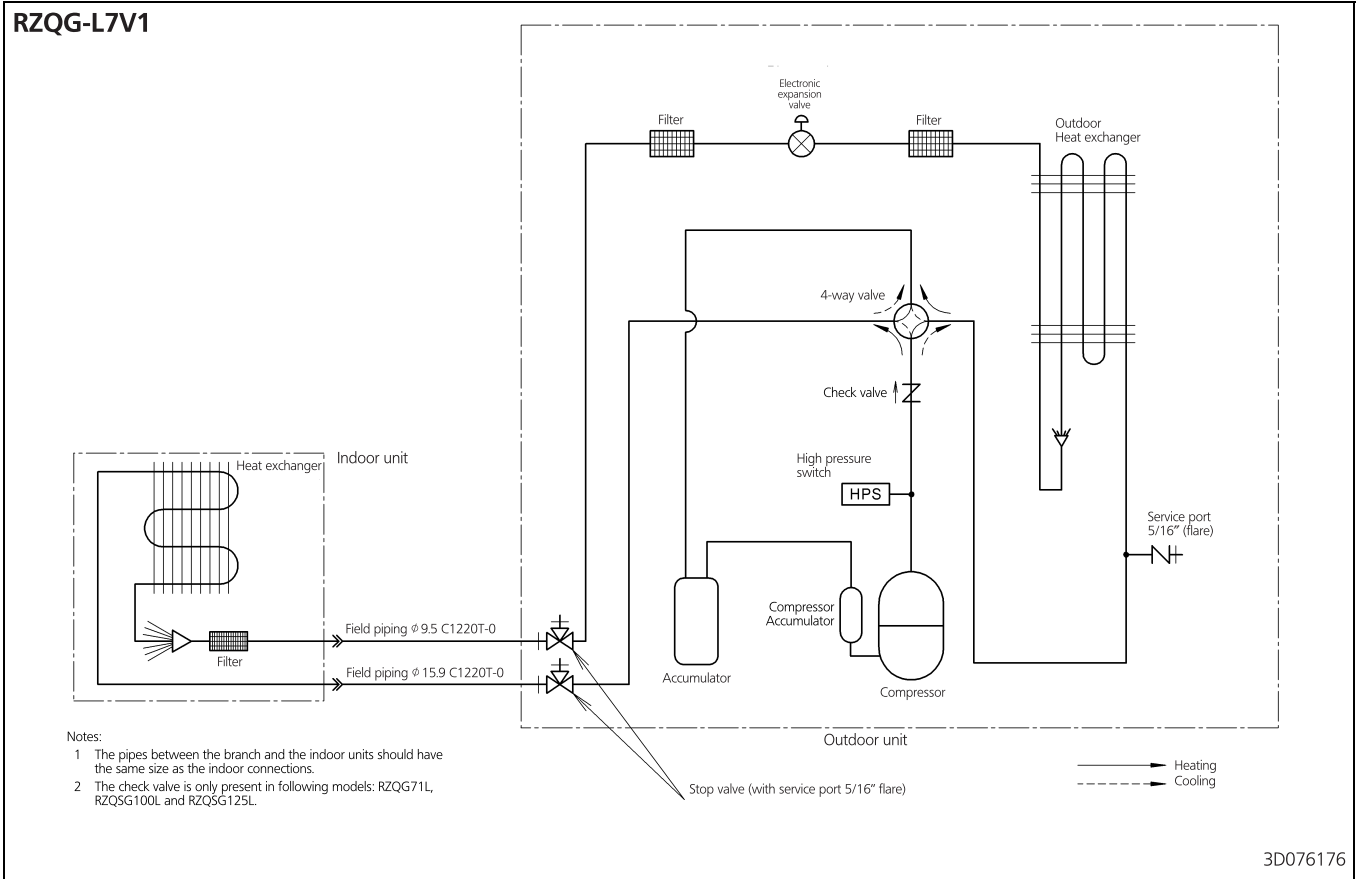

9 Piping diagrams

9 - 2 Piping Diagram Twin Application

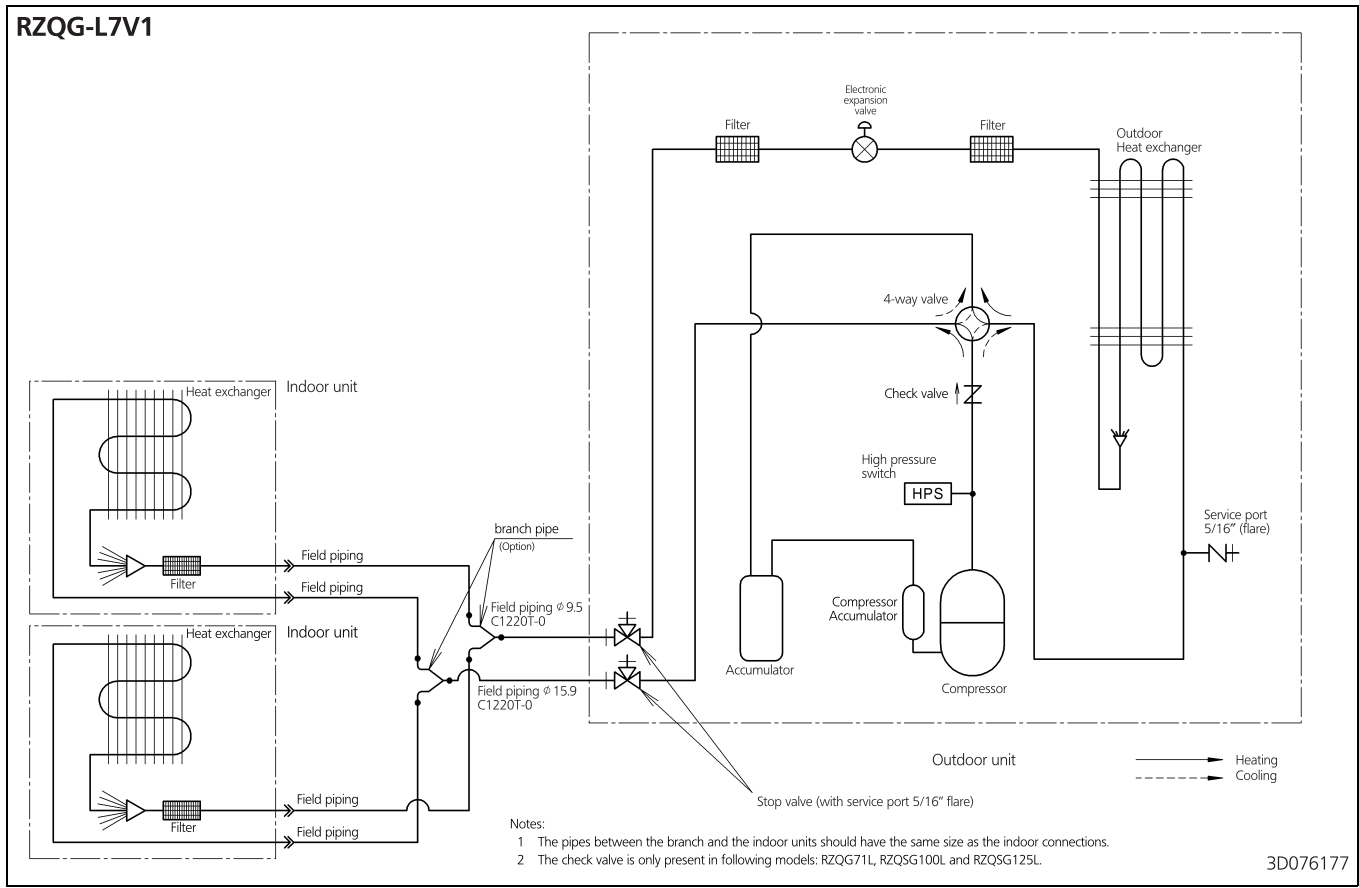

9 Piping diagrams

9 - 3 Piping Diagram Triple Application

9

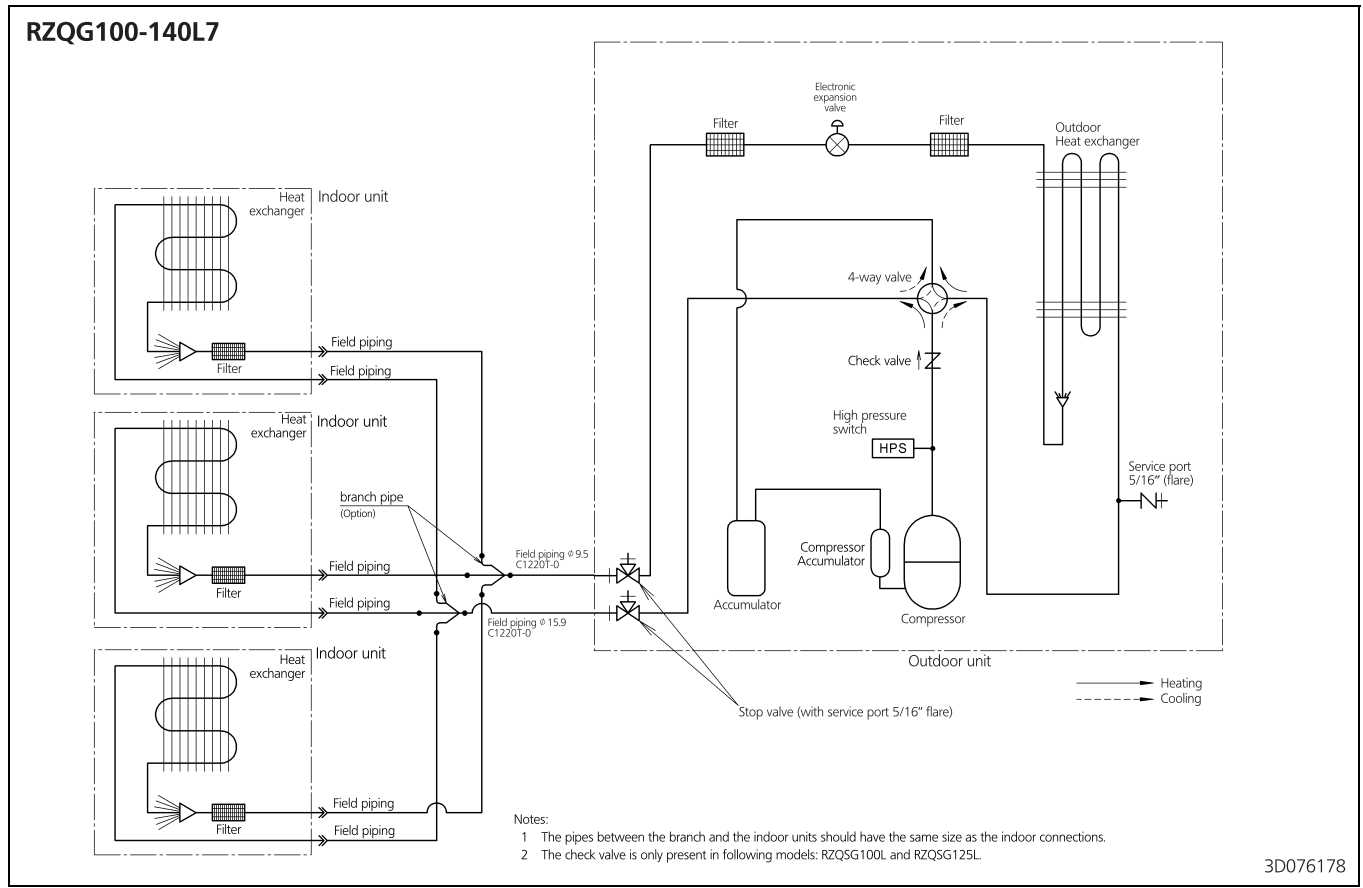

9 Piping diagrams

9 - 4 Piping Diagram Double Twin Application

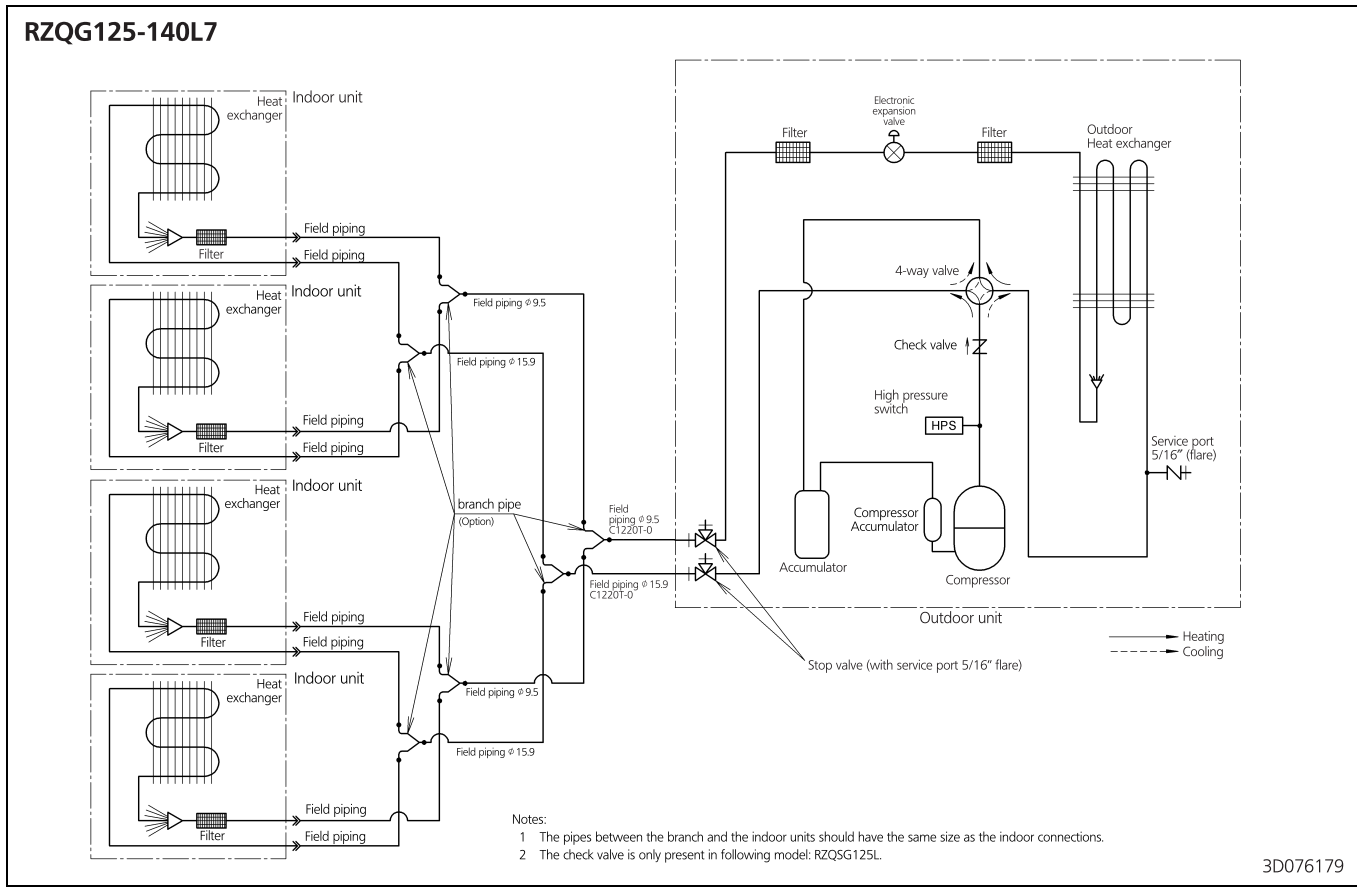

10 Wiring diagrams

10 - 1 Wiring Diagrams - Single Phase

10

RZQG71L7V1

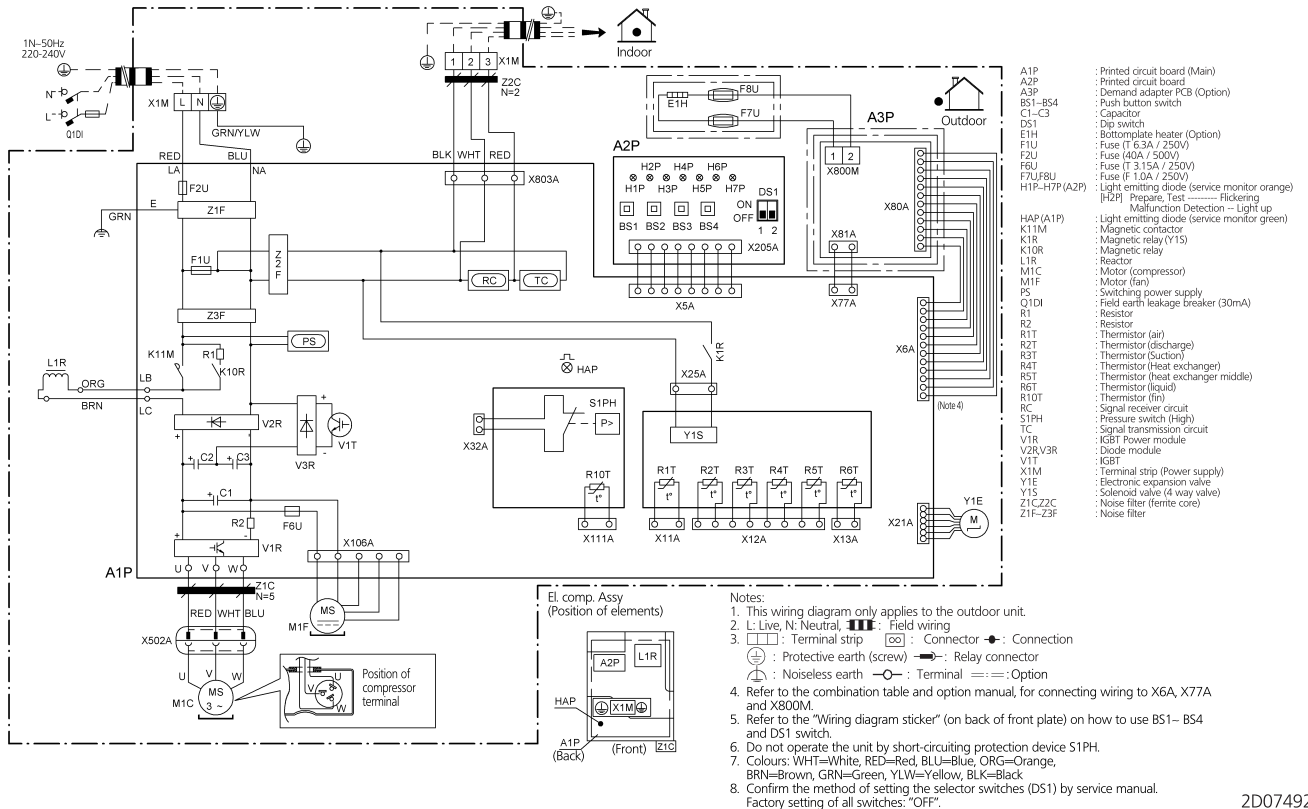

D2074927A

RZQG100-140L7V1

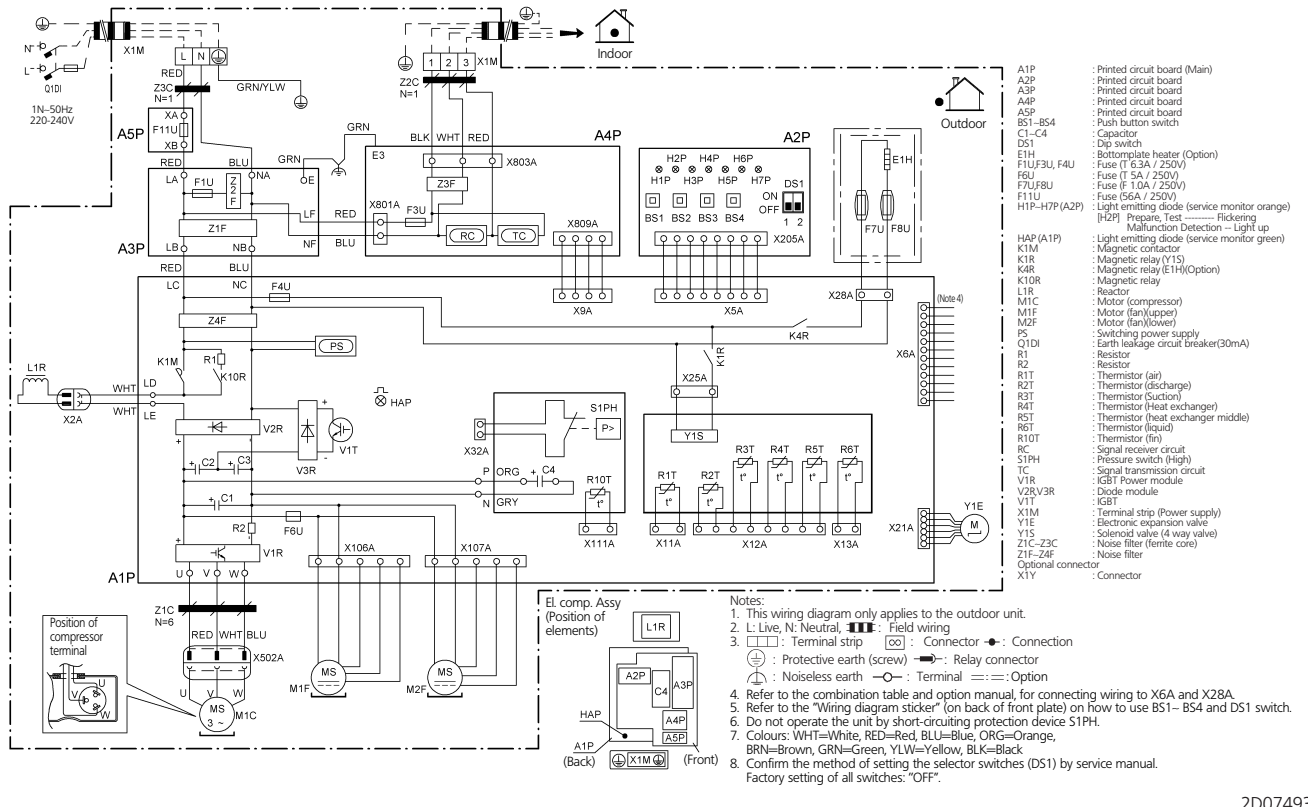

D2074931A

11 Sound data

11 - 1 Sound Power Spectrum

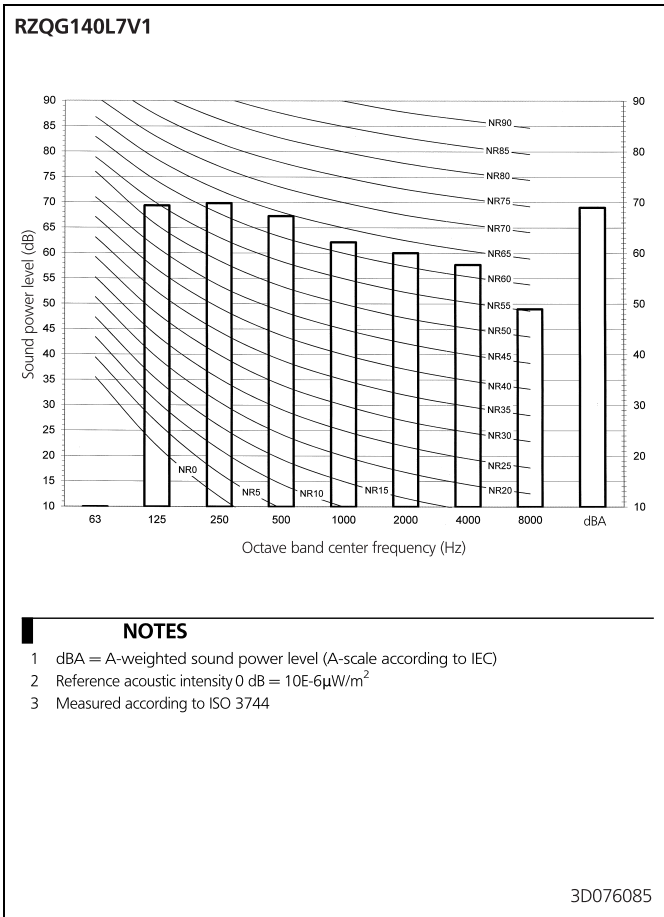
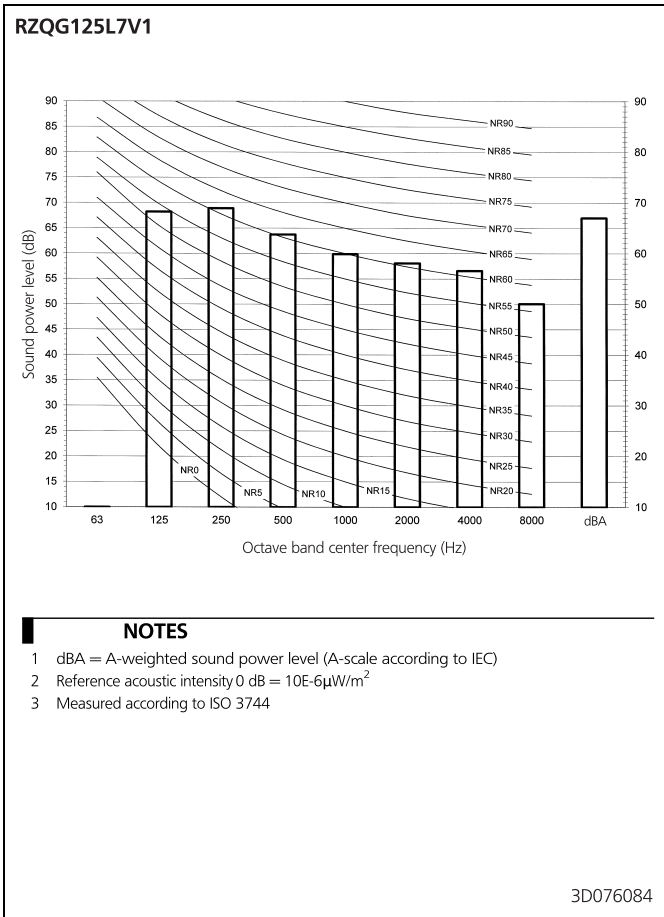
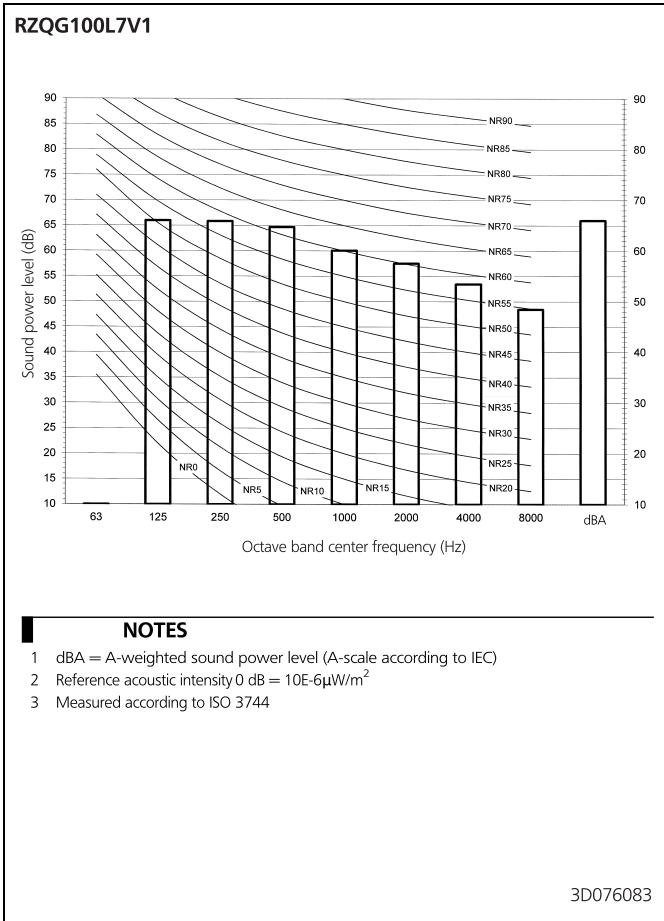
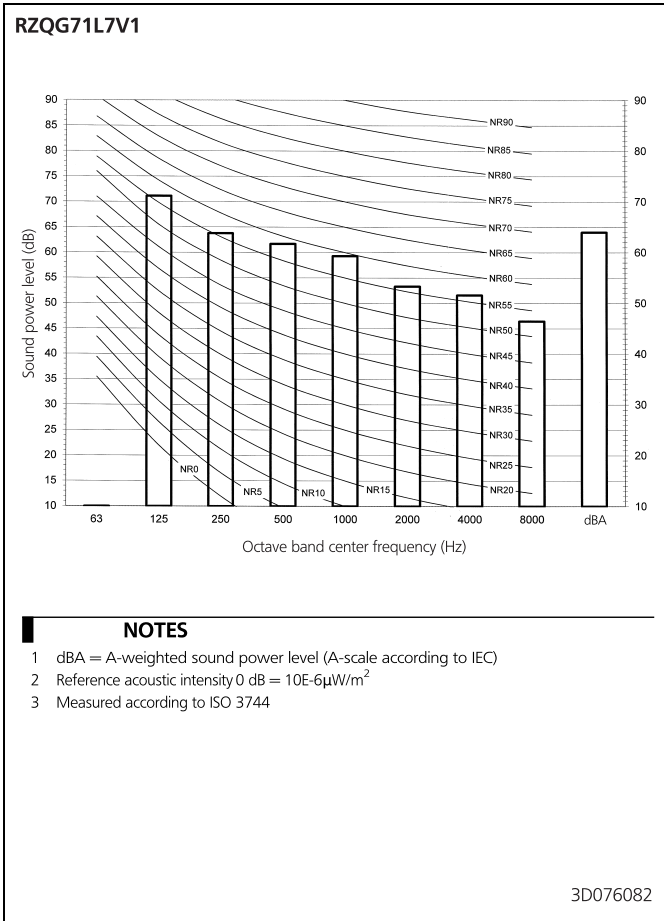

11 Sound data

11 - 2 Sound Pressure Spectrum - Cooling

11

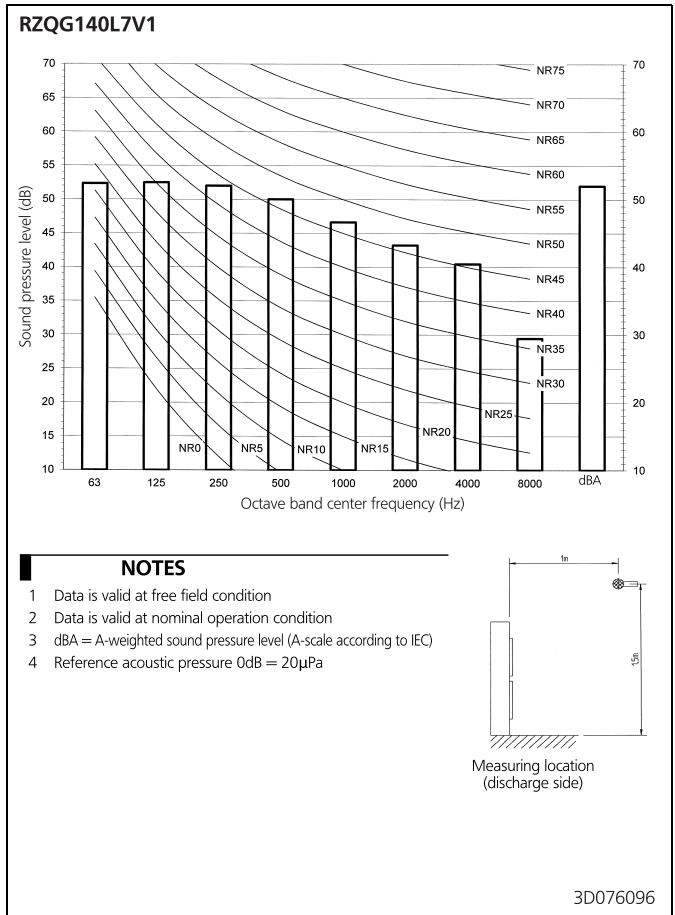
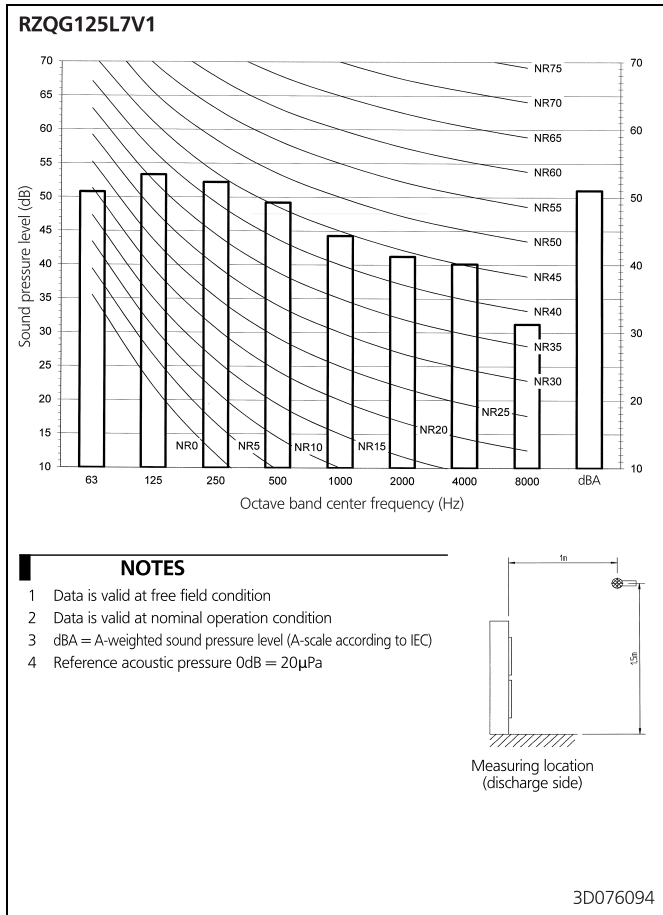
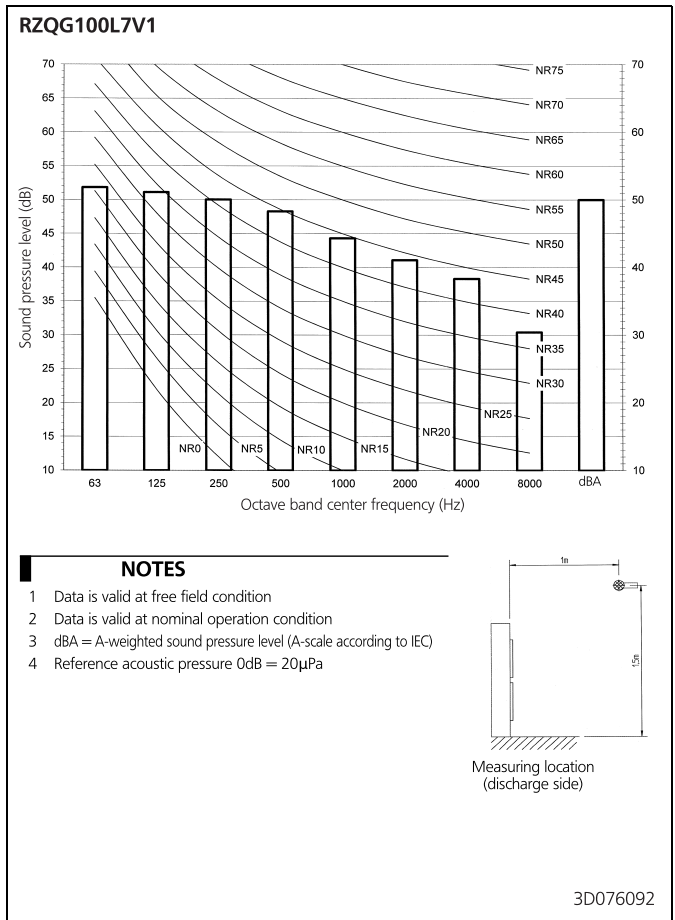
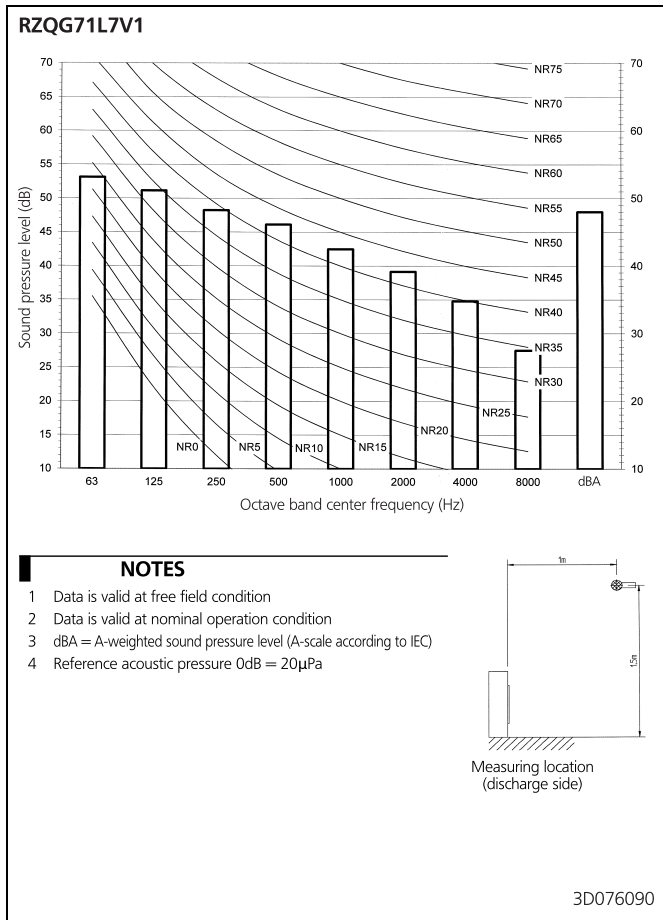

11 Sound data

11 - 3 Sound Pressure Spectrum - Heating

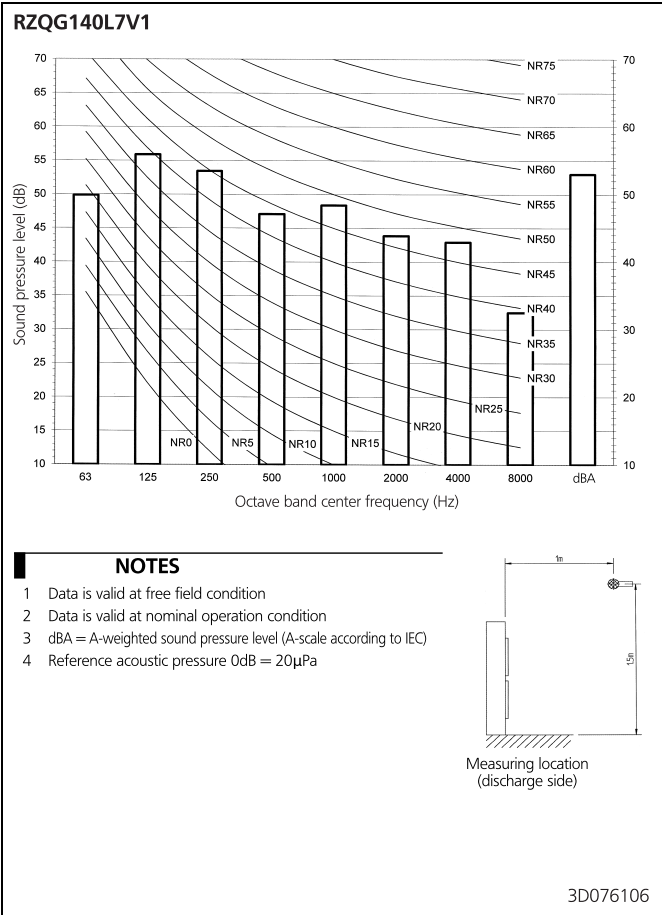
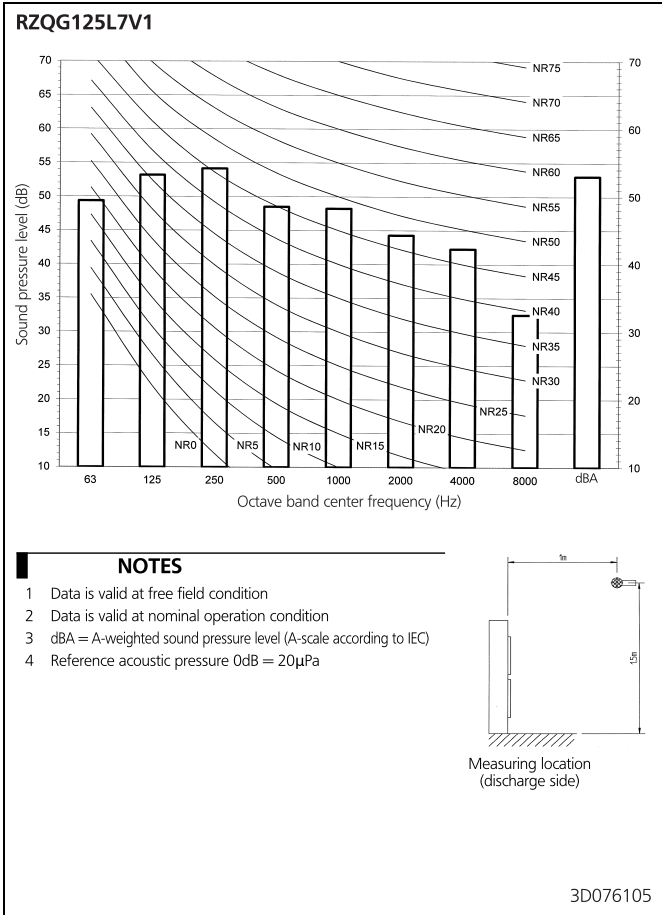
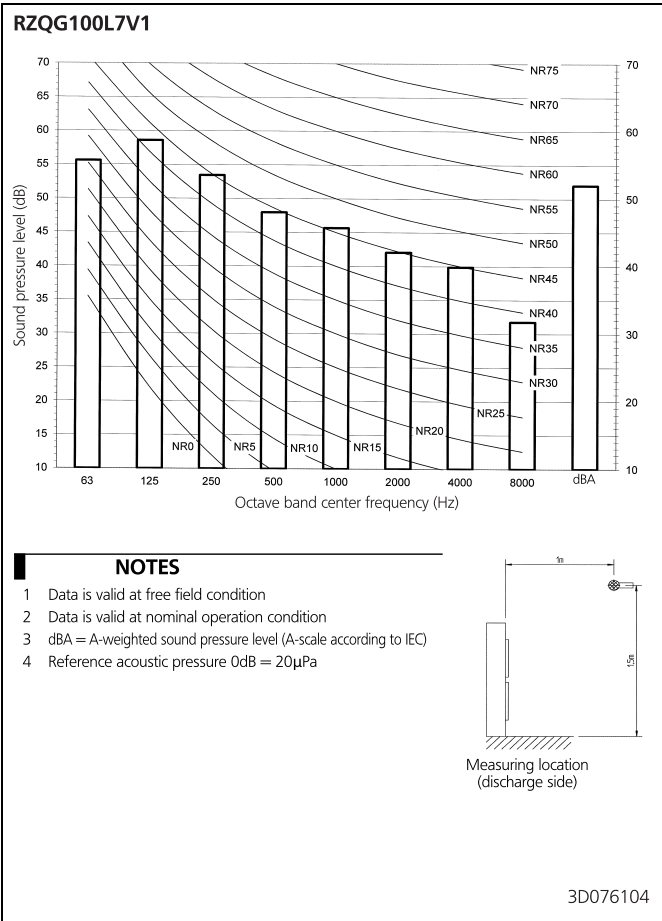
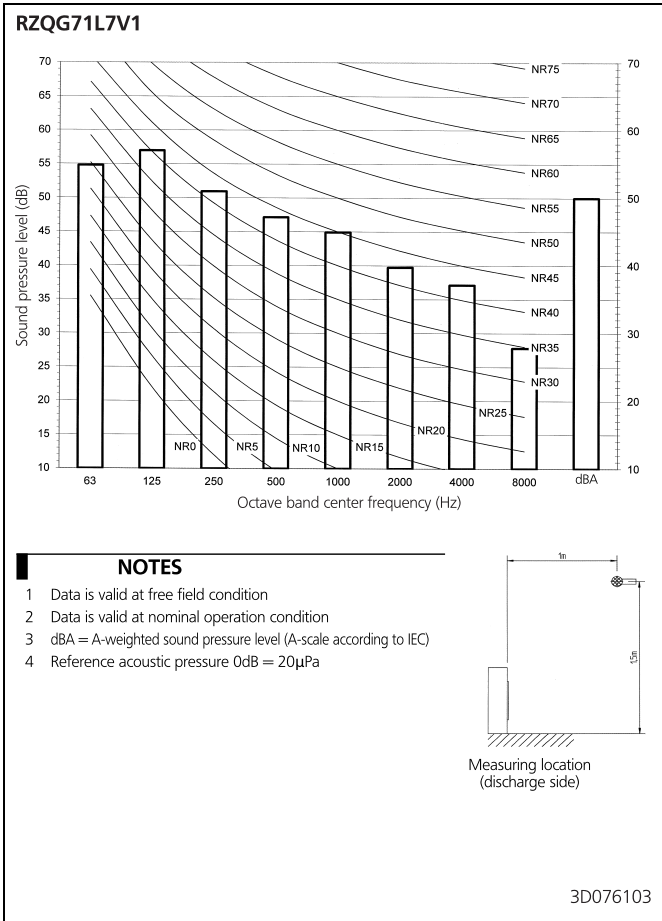

11 Sound data

11 - 4 Sound Pressure Spectrum Quiet Mode

11

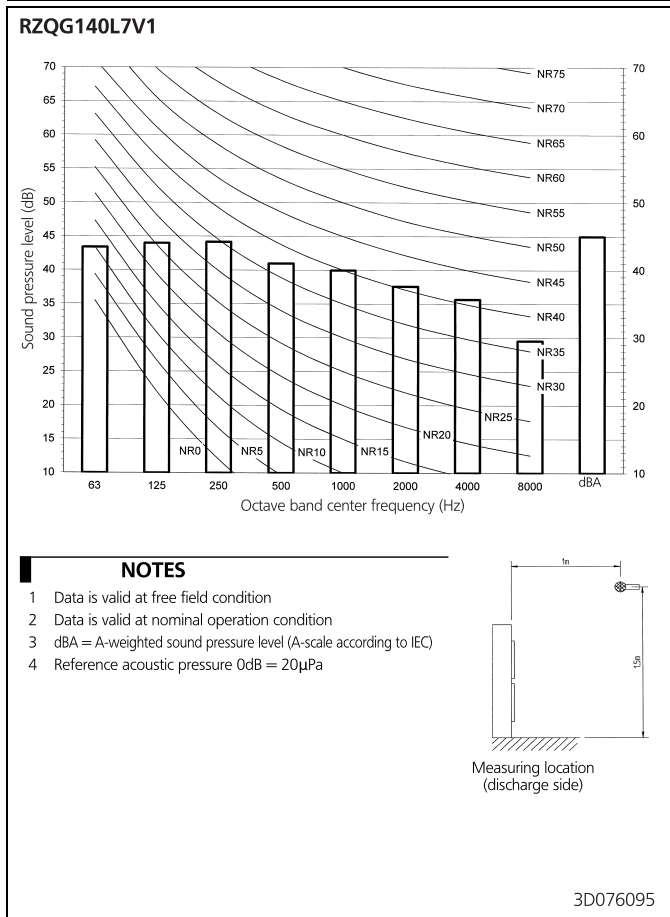
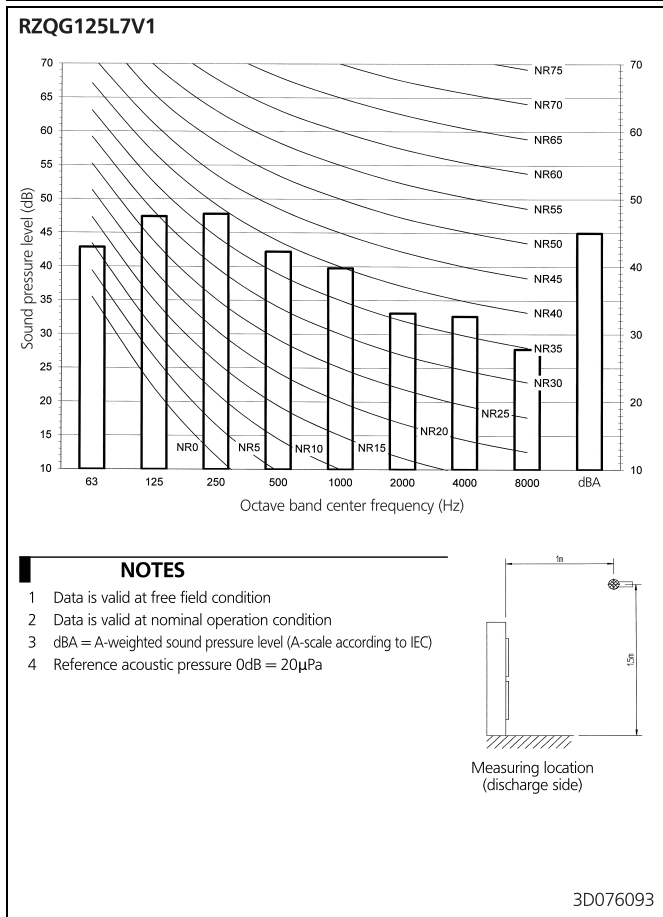
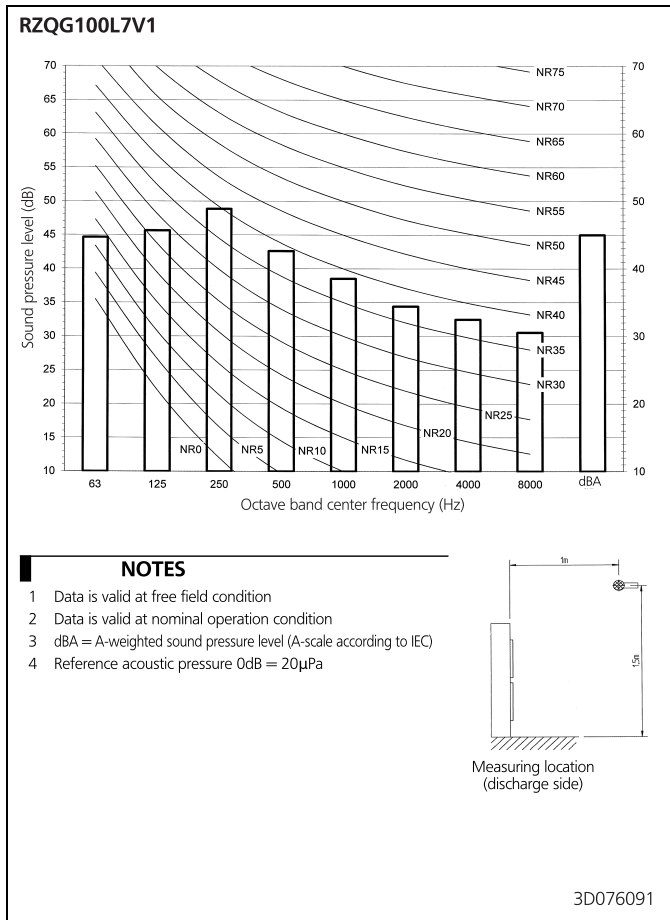
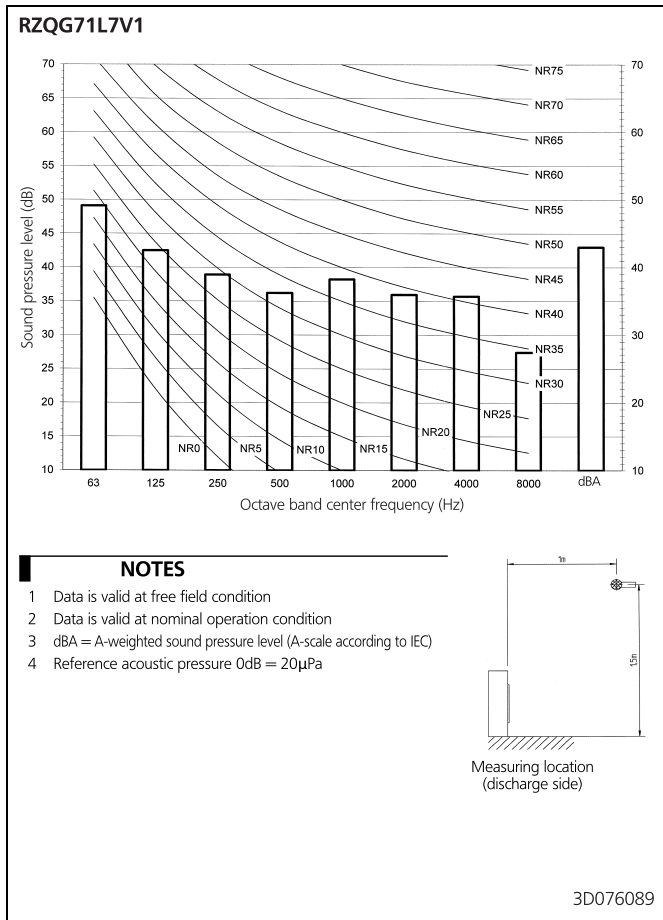

12 Installation

12 - 1 Installation Method

RZQG-L7

Installation service space

The measure of these values is "mm".

(A) When there are obstacles on suction sides.

• No obstacle above

- ① Stand-alone installation
 - Obstacle on the suction side only

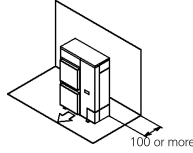

- Obstacle on both sides and suction side, too

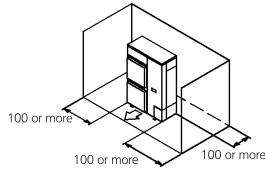

- ② Series installation (2 or more) (Note 1)
 - Obstacle on the suction side and both sides

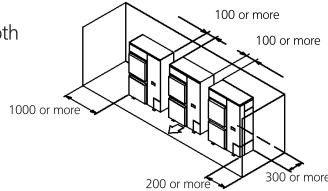

• Obstacle above, too.

- ① Stand-alone installation
 - Obstacle on the suction side, too

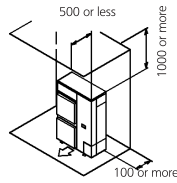

- Obstacle on both sides and suction side, too

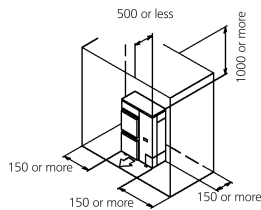

- ② Series installation (2 or more) (Note 1)
 - Obstacle on the suction side and both sides

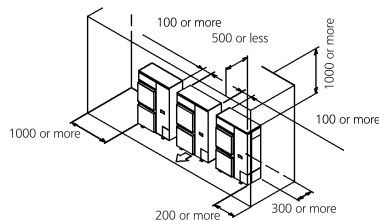

(B) When there are obstacles on discharge sides.

• No obstacle above

- ① Stand-alone installation
 - Obstacle on the discharge side only

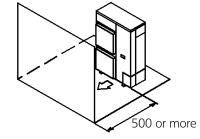

- ② Series installation (2 or more) (Note 1)
 - Obstacle on the discharge side only

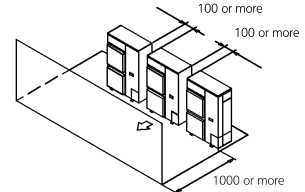

• Obstacle above, too

- ① Stand-alone installation
 - Obstacle on the discharge side only, too

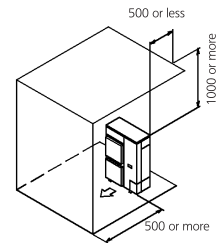

- ② Series installation (2 or more) (Note 1)
 - Obstacle on the discharge side

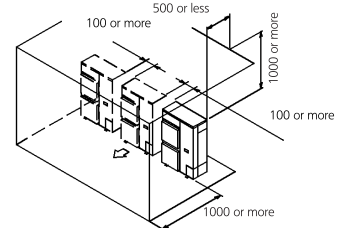

(C) When there are obstacles on both suction and discharge sides.:

Pattern 1

When the obstacles on the discharge side is higher than the unit. (L>H)
(There is no limit for the height of obstructions on the suction side.)

• No obstacle above

- ① Stand-alone installation
 - No obstacle above

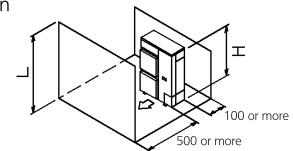

- ② Series installation (2 or more) (Note 1)
 - No obstacle above

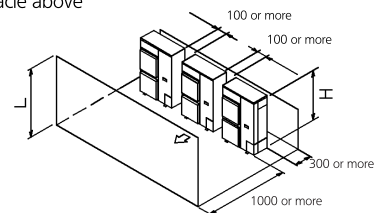

3D069554

12 Installation

12 - 1 Installation Method

RZQG-L7

● **Obstacle above, too**

① Stand-alone installation (Note 2)

- When there are obstacles on suction, discharge and top sides.

The relations between H, A and L are as follows.

	L	A
$L \leq H$	$L \leq 1/2 H$ 750 or more	250 or more
	$1/2 H < L \leq H$	1000 or more
$L > H$	Set the stand as : $L \leq H$ Refer to the column of $L \leq H$ for A	

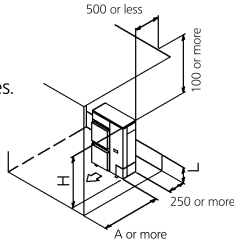

② Series installation (2 or more) (Note 1, 2)

- When there are obstacles on suction, discharge and top sides.

The relations between H, A and L are as follows.

	L	A
$L \leq H$	$L \leq 1/2 H$ 1000 or more	250 or more
	$1/2 H < L \leq H$	1250 or more
$L > H$	Set the stand as : $L \leq H$ Refer to the column of $L \leq H$ for A	

Limit of series installation is 2 units.

Pattern 2

When the obstacle on the discharge side is lower than the unit ($L \leq H$) (There is no limit for the height of obstructions on the suction side.)

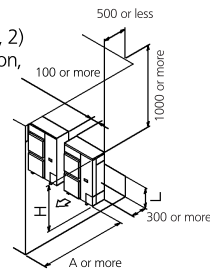

● **No obstacle above**

① Stand-alone installation

- No obstacle above

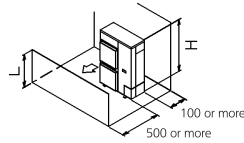

② Series installation (2 or more) (Note 1, 2)

- When there are obstacles on both suction and discharge sides.

The relations between H, A and L are as follows.

	L	A
$L \leq H$	$L \leq 1/2 H$ 250 or more	250 or more
	$1/2 H < L \leq H$	300 or more

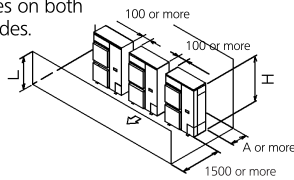

● **obstacle above**

① Stand-alone installation (Note 2)

- When there are obstacles on suction, discharge and top sides.

The relations between H, A and L are as follows.

	L	A
$L \leq H$	$L \leq 1/2 H$ 100 or more	200 or more
	$1/2 H < L \leq H$	200 or more
$L > H$	Set the stand as : $L \leq H$ Refer to the column of $L \leq H$ for A	

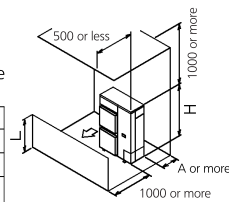

② Series installation (2 or more) (Note 1, 2)

- When there are obstacles on suction, discharge and top sides.

The relations between H, A and L are as follows.

	L	A
$L \leq H$	$L \leq 1/2 H$ 250 or more	250 or more
	$1/2 H < L \leq H$	300 or more
$L > H$	Set the stand as : $L \leq H$ Refer to the column of $L \leq H$ for A	

Limit of series installation is 2 units.

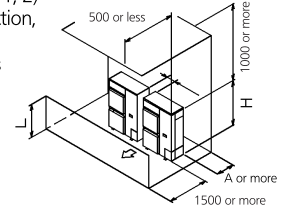

(D) Double-decker installation

① Obstacle on the discharge side. (1)

- Do not exceed two levels for stacked installation.
- Install a roof cover similar to A (field supply), as outdoor units with downward drainage are prone to dripping and freezing.
- Install the upper-level outdoor unit so that its bottom plate is a sufficient height above the roof cover. This is to prevent the buildup of ice on the underside of the bottom plate.

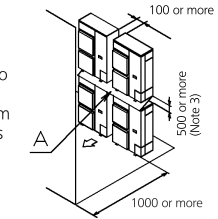

② Obstacle on the suction side. (1)

- Do not exceed two levels for stacked installation.
- Install a roof cover similar to A (field supply), as outdoor units with downward drainage are prone to dripping and freezing.
- Install the upper-level outdoor unit so that its bottom plate is a sufficient height above the roof cover. This is to prevent the buildup of ice on the underside of the bottom plate.

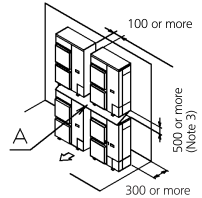

(E) Multiple rows of series installation (on the rooftop, etc.)

① One row of stand-alone installation

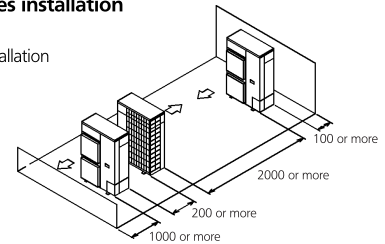

② Rows of series installation (2 or more)

The relations between H, A and L are as follows.

	L	A
$L \leq H$	$L \leq 1/2 H$ 250 or more	250 or more
	$1/2 H < L \leq H$	300 or more
$L > H$	Can not be installed	

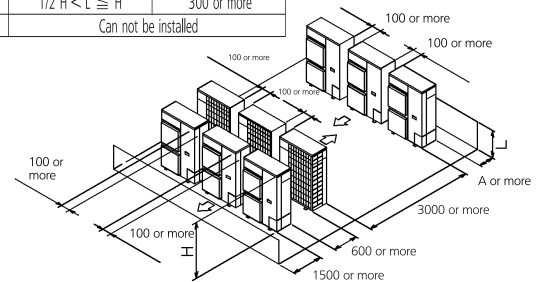

NOTES

- 1 In case of the sideways's piping, make a 100mm gap between the unit above.
- 2 Close the bottom of the installation frame to prevent the discharged air from being bypassed.
- 3 It is not necessary to install a roof cover if there is no danger of drainage dripping and freezing. In this case, the space between the upper and lower outdoor units should be at least 100mm. Close off the gap between the upper and lower units so there is no re-intake of discharged air.

In all of us,
a green heart



Daikin's unique position as a manufacturer of air conditioning equipment, compressors and refrigerants has led to its close involvement in environmental issues. For several years Daikin has had the intention to become a leader in the provision of products that have limited impact on the environment. This challenge demands the eco design and development of a wide range of products and an energy management system, resulting in energy conservation and a reduction of waste.



Daikin Europe N.V. participates in the Eurovent Certification programme for Air conditioners (AC), Liquid Chilling Packages (LCP) and Fan coil units (FCU). Check ongoing validity of certificate online: www.eurovent-certification.com or using: www.certiflash.com*

The present leaflet is drawn up by way of information only and does not constitute an offer binding upon Daikin Europe N.V. Daikin Europe N.V. has compiled the content of this leaflet to the best of its knowledge. No express or implied warranty is given for the completeness, accuracy, reliability or fitness for particular purpose of its content and the products and services presented therein. Specifications are subject to change without prior notice. Daikin Europe N.V. explicitly rejects any liability for any direct or indirect damage, in the broadest sense, arising from or related to the use and/or interpretation of this leaflet. All content is copyrighted by Daikin Europe N.V.



EEDEN12-100

Daikin products are distributed by: